

# FORLIGHT 2020







**FORLIGHT**, la marca que LEDS C4 lanzó al mercado en 2015, ofrece una gama de soluciones lumínicas primando ofrecer productos cuidadosamente seleccionados para los más de 140 países donde estamos presentes. Conscientes de la importancia de seguir proponiendo a todos nuestros clientes y aliados comerciales productos que solucionen todas sus necesidades, en este nuevo catálogo de Forlight encontrarán los **productos imprescindibles para iluminar hogares y proyectos de uso no intensivo**.

**Nuestro propósito** es hacer llegar al mayor número de consumidores unos diseños actualizados, prácticos y eficaces **al mejor precio posible**, y todo con el servicio y garantía que LEDS-C4 imprime a cada una de sus marcas.

Los diseños de **FORLIGHT**, ideados en Europa siguiendo las tendencias más actuales, incluyen productos de Exteriores, Técnicos y Decorativos. En todos ellos destacan la funcionalidad y su fácil instalación. Detrás de **FORLIGHT** hay un gran equipo profesional consciente de la importancia de cuidar cada detalle.

El éxito obtenido con el anterior catálogo nos ha reafirmado en nuestra idea de abrir nuevas oportunidades de producto para todos nuestros clientes. En este catálogo **FORLIGHT 2020** presentamos un gran número de novedades y mejoras, con las que esperamos seguir aportando al mercado productos que cubran las demandas de un público cada vez más exigente. Esperamos que este nuevo catálogo sea una herramienta valiosa para ustedes y podamos continuar generando muchos más éxitos compartidos.

FORLIGHT... Easy Light!

[www.forlight.com](http://www.forlight.com)

**FORLIGHT**, the LEDS-C4 brand, launched in 2015, offers a wide range of lighting solutions giving priority to the carefully selected products for each of the 140 countries where we are present. We're aware of how important it is to continue developing products that satisfy our clients' and commercial partners' needs, and the new Forlight catalogue presents a range of must-have **products to light homes and use in projects that do not require continuous lighting**.

**Our purpose** is to reach the largest number of customers with updated, practical and efficient designs coupled **with the best price possible**, and all of that with a service and guarantee that LEDS-C4 imposes on all their brands.

**FORLIGHT** designs, conceived in Europe following the ultimate trends, include Exterior, Technical and Decorative products. In all of them, functionality prevails with additional emphasis on their easy installation. Behind **FORLIGHT** you will be able to find the most professional team, with an outstanding grasp on the importance of taking care of even the smallest detail.

The success of our last catalogue reassured us with our idea of opening new product opportunities for all our clients. So, in this **FORLIGHT 2020** catalogue, we present a wide range of innovations and improvements of which we will continue to develop to meet the requirements and demands of customers old and new. We hope this new catalogue becomes a valuable tool for you and we look forward to creating many more success stories together.

FORLIGHT... Easy Light!

[www.forlight.com](http://www.forlight.com)

**FORLIGHT**, la marque lancée par LEDS-C4 en 2015, offre une gamme de solutions d'éclairage qui privilégie le rapport qualité-prix. Forts de 25 ans d'expérience dans la fabrication et la conception de luminaires, nous proposons des produits soigneusement sélectionnés pour les plus de 140 pays où nous sommes présents. Conscients de l'importance de continuer à proposer à tous nos clients et partenaires commerciaux des produits qui répondent à tous leurs besoins, nous vous offrons dans ce nouveau catalogue de Forlight les **articles indispensables pour vos projets d'éclairage résidentiel et projets à usage non intensif**.

**Notre but** est de faire parvenir au plus grand nombre de consommateurs des modèles contemporains, pratiques et efficaces **au meilleur prix possible**, le tout avec le service et la garantie dont LEDS-C4 dote chacune de ses marques.

Conçus en Europe en suivant les tendances les plus actuelles, les modèles de **FORLIGHT** comprennent des produits d'extérieur, technique et décoratifs. Privilégiant fonctionnalité, tous les articles sont en outre faciles à installer. **FORLIGHT** est le fruit du travail d'une équipe très professionnelle, qui veille à tout moment à prendre soin du moindre détail.

Le succès qu'a remporté le dernier catalogue nous a confortés dans l'idée de créer de nouvelles opportunités de produits pour tous nos clients. Ce catalogue **FORLIGHT 2020** est pour nous l'occasion de présenter un grand nombre de nouveautés et de perfectionnements, dans l'espoir de continuer à proposer des produits qui répondent aux attentes d'un public de plus en plus exigeant. Nous espérons que ce nouveau catalogue vous sera utile à tous et que nous pourrions continuer à vivre de nombreux succès ensemble.

FORLIGHT... Easy Light!

[www.forlight.com](http://www.forlight.com)

## Ejemplo de embalaje Packaging example Exemple d'emballage



**Nuestras luminarias tienen las fichas de producto y las guías de instalación disponibles para ser descargadas. Los datos fotométricos son compatibles para los principales software de iluminación.**

**Our luminaires have technical specifications and installation guides available to be downloaded. Photometric data compatible with the main lighting software.**

**Vous pouvez télécharger toutes les fiches techniques et les guides d'installation. Les données photométriques de nos luminaires sont compatibles avec les principaux logiciels d'éclairage.**

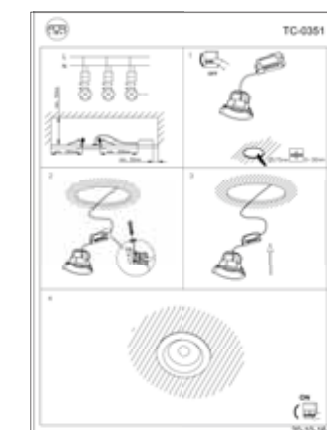
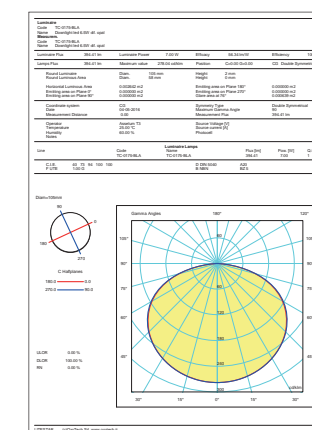

DIALux

AGI32  
lighting software  
by Lightmap Analysis

RELUX®  
light simulation tools

## Página web de Forlight Forlight website Site internet de Forlight

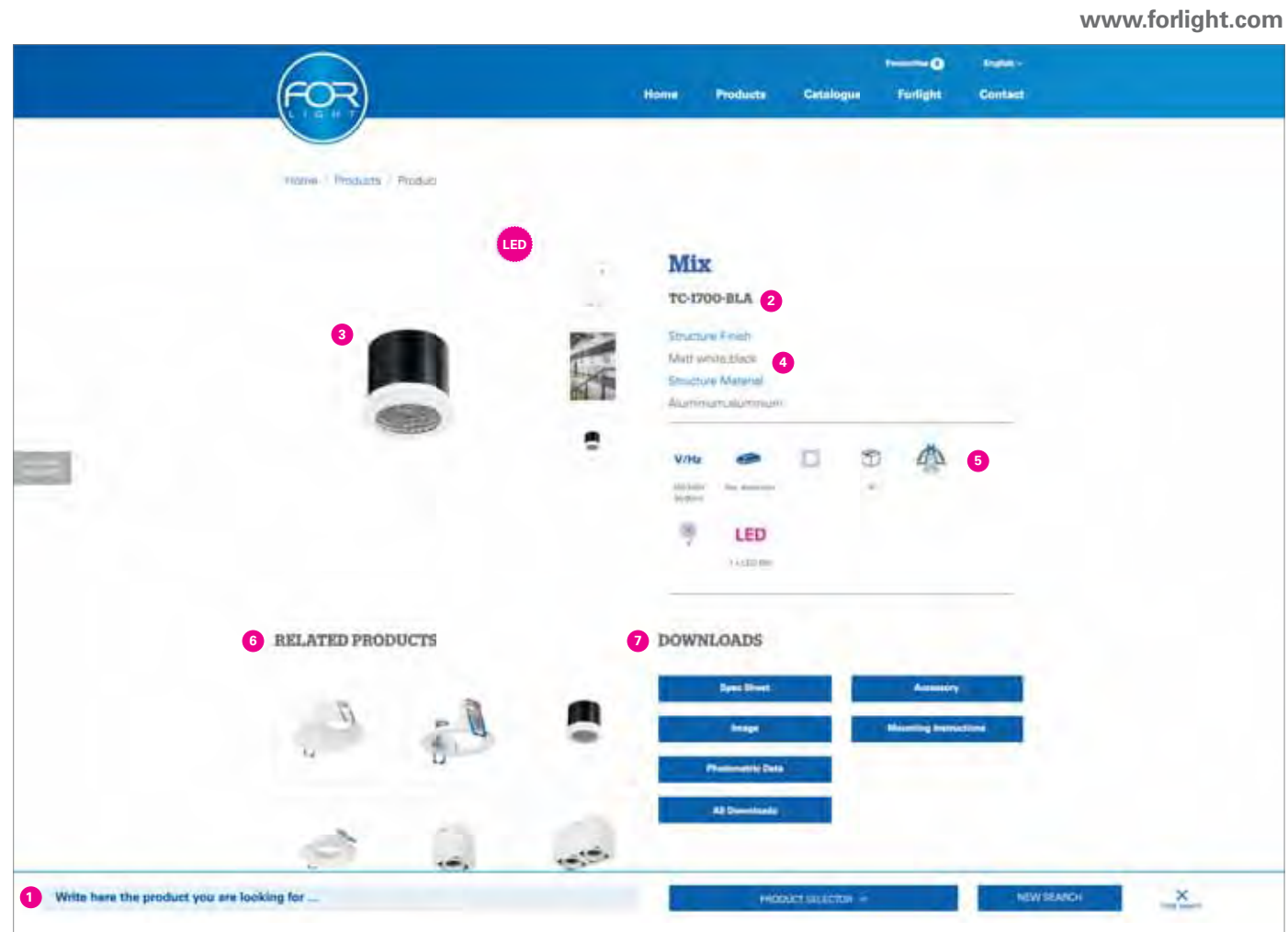

1 Buscador interno.  
Site Search.  
Outil de recherche interne.

2 Modelo y referencia del producto según su acabado.  
Product model and reference number based on characteristics.  
Modelo y referencia del producto según su acabado.

3 Imagen de producto aislado, en ambiente y dimensiones.  
Product only image, product in use image and dimensions.  
Image du produit isolé, sur site et dimensions.

4 Información de materiales y acabados.  
Information about Materials and Finishes.  
Informations matériaux et finitions.

5 Simbología.  
Symbols.  
Symboles.

6 Productos y accesorios relacionados.  
Related products and accessories.  
Produits et accessoires connexes.

7 Descarga de todos los datos.  
Download all the information.  
Téléchargement de toutes les données.

## ¿Cómo utilizar este catálogo? How to use the catalogue? Comment s'utilise ce catalogue?

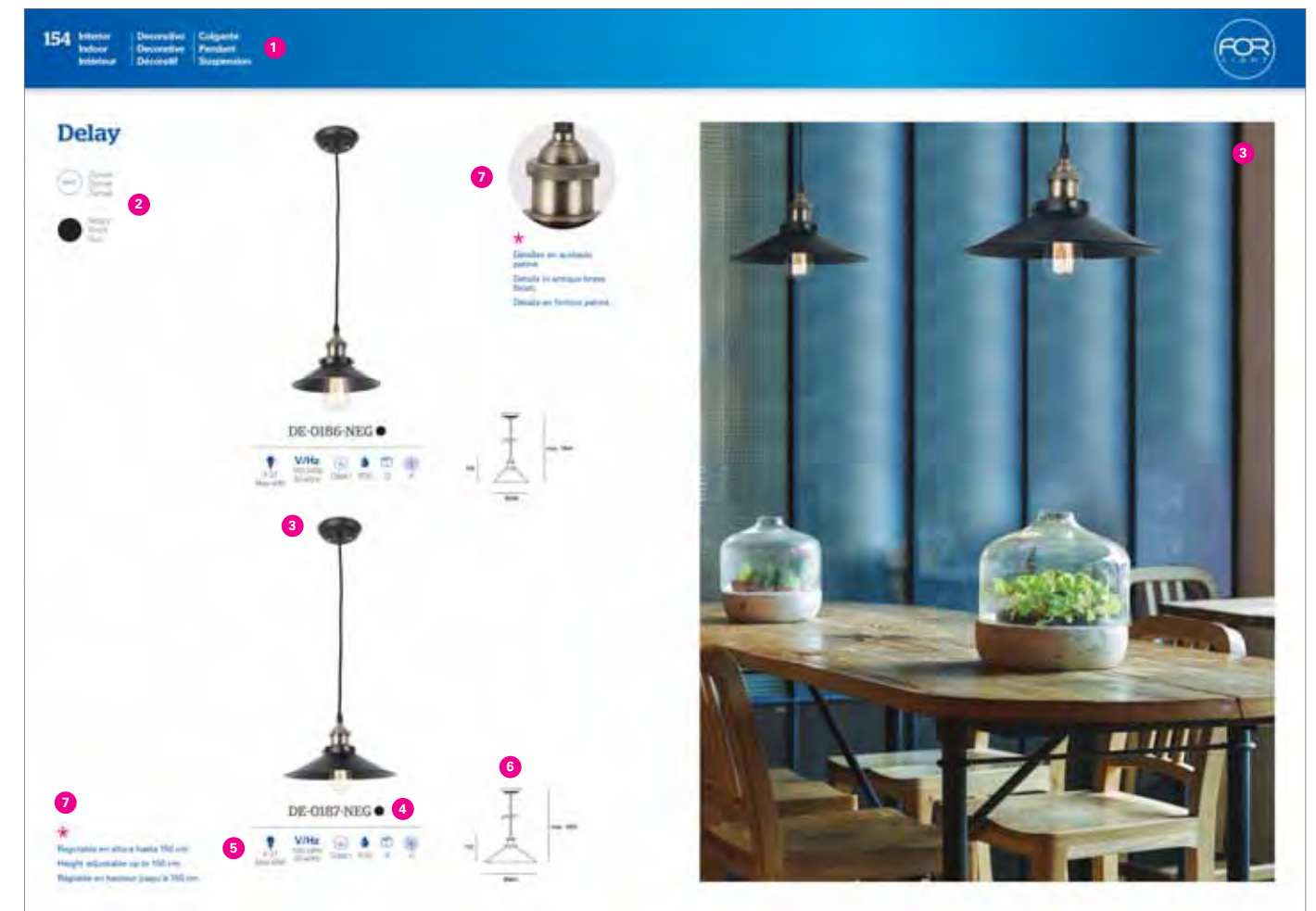

1 Sección de producto dentro del catálogo.  
Product Section in the Catalogue.  
Type de produits du catalogue.

2 Información de materiales y acabados.  
Information about Materials and Finishes.  
Informations matériaux et finitions.

3 Imagen de producto aislado y en ambiente.  
Isolated Product and Assembled Product Images.  
Image du produit seul et ambiances.

4 Referencia del producto según su acabado.  
Product Reference according to Finish.  
Référence du produit selon sa finition.

5 Características técnicas y de utilidad del producto.  
Technical Characteristics and Product Use.  
Caractéristiques techniques et utilisation du produit.

6 Dimensiones y montaje del producto.  
Measures and Product Assembly.  
Dimensions et montage du produit.

7 Información y fotos adicionales del producto.  
Additional photos and product information.  
Photos et informations supplémentaires sur le produit.



# SMART

Iluminación modular para techo  
Modular downlight  
Plafond d'éclairage modulaire



**N** Mix  
21

**N** Hide  
21

Downlights empotrados  
Recessed downlights  
Downlight encastrés



**N** Easy  
23

Pared o techo  
Wall or ceiling  
Mur ou au plafond



**N** Olra  
24

Colección  
Family  
Familie



**N** Smart Outdoor Lighting  
26



Key  
36

Elit  
38

Downlights de superficie  
Surface downlights  
Downlight de surface



Tub  
41

**N** Fox  
42

**N** Easy Surface  
57, 58

Panel led  
Led panel  
Pavé led



Square  
62

Downlights empotrados  
Recessed downlights  
Downlight encastrés



**N** Fox  
42

**N** Hide  
46



Minor  
48

Top  
49

Sound Plus  
50

Bala  
52

**N** Easy  
54, 55

**N** Wide  
60

# Técnico Technical Technique

Proyector de carril  
Track spotlight  
Projecteur et rail



Onyx  
30

Iko  
32

Kyo  
34

Cone  
35



**N** Base  
64

Dorit  
66

Cardan  
68

Cardan  
70

**Illuminación modular para techo**  
**Modular downlight**  
**Plafond d'éclairage modulaire**



**N Mix**  
44, 45

FIXED

ADJUSTABLE



DEEP

VISUAL COMFORT

VISUAL COMFORT  
ADJUSTABLE

IP65

44, 45

**Sistema linear de superficie y suspendido**  
**Suspended and surface linear system**  
**Système linéaire suspendu et de surface**

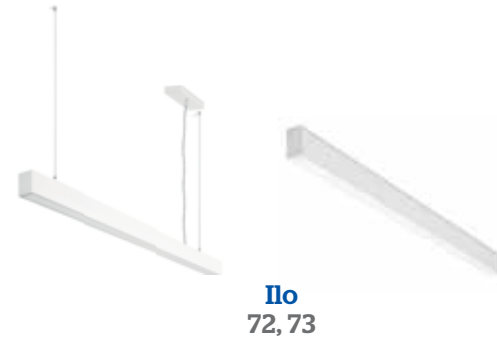

**Ilo**  
72, 73



**Baños**  
**Bath**  
**Salle de bains**

**Mix**  
44, 45

**Minor**  
48

IP65

**Exterior**  
**Outdoor**  
**Extérieur**

**Empotrable de suelo**  
**Uplight recessed**  
**Encastré sol**



**Ringo**  
76, 78

**Tidian**  
80

**Empotrable de pared**  
**Recessed wall fixture**  
**Aplique encastré**



**Tamesis**  
82

**Stair**  
84

**Face**  
84

**Proyectores**  
**Spotlights**  
**Projecteurs**



**Picnic**  
86

**Post**  
88

**April**  
90

**N Neo**  
92

**Tidian**  
92



**Minimal Green**  
95

**Minimal**  
95

**Luminaria de superficie**  
**Surface mounted**  
**Luminaire de surface**



**Propper**  
96

**Selene**  
98

**Ford**  
100, 101

**Rhino**  
102



**Orion**  
136, 137



**N New flash**  
152

**Colgantes  
Pendants  
Suspensions**



**Rhiana**  
104



**Pergola**  
106

**Balizas  
Bollards  
Balises**



**Arrow**  
164



**N Zip**  
165

**Colección  
Family  
Familie**



**N Alfil**  
167



**Yika**  
169



**Mandela**  
171

**Apliques de pared  
Wall fixtures  
Appliques**



**Ara**  
116



**Kapa**  
118



**N Mocca**  
120



**Box**  
122



**Willow**  
124



**Rex**  
126



**Cube**  
129



**Koral**  
172, 173



**Siljan**  
174, 175



**Siros**  
178, 179



**Adur**  
180



**Slim**  
130



**Loyd**  
132



**Karen**  
134



**Mayor**  
138



**Jumbo**  
140



**Serenate**  
142



**Samper**  
143



**Noa**  
144



**Area**  
145

**Chillout  
Chillout  
Chillout**



**Moon**  
108



**Sphere**  
108



**N Mush**  
110



**N Magnet**  
112



**Night**  
114



**N Dual**  
146



**Grove**  
146, 148, 150



**Solar 350**  
153



SOLAR

SENSOR



**Litus**  
154



SENSOR



**Clock**  
156



**Elix**  
157



**Siluet**  
158



**Lord**  
158



**Sirena**  
159



**Osaka**  
160



**Prisman**  
162



**Road**  
163



**Avenue**  
176

**Decorativo  
Decorative  
Décoratif**

**Colgantes  
Pendants  
Suspensions**



**N Bowl**  
184



**N Thin**  
186



**King**  
188



**N Bloom**  
190

**Nube**  
192, 193

**Vira**  
194

**Dixie**  
196

**Pray**  
196

Pared o techo  
Wall or ceiling  
Mur ou au plafond

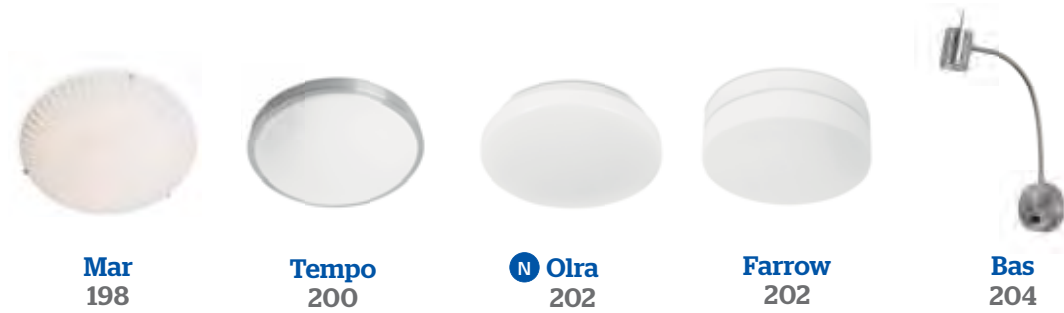

**Mar**  
198

**Tempo**  
200

**N Olra**  
202

**Farrow**  
202

**Bas**  
204

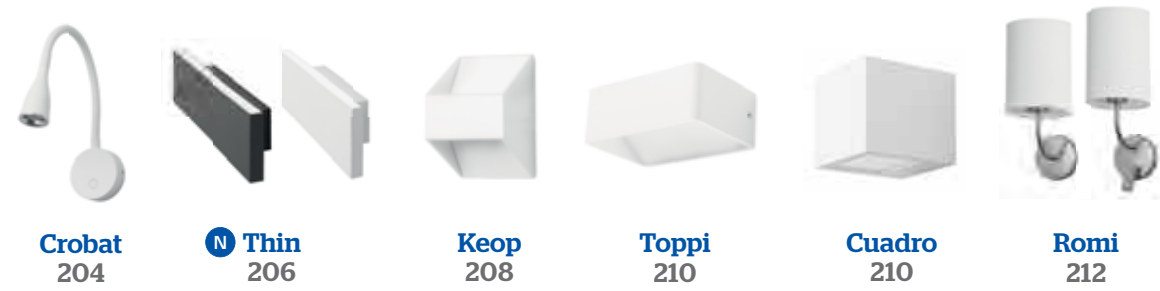

**Crobot**  
204

**N Thin**  
206

**Keop**  
208

**Toppi**  
210

**Cuadro**  
210

**Romi**  
212

Sobremesas y pies de salón  
Table Lamps and floor lamps  
Lampes de table et lampadaires



**N Mush**  
214

**N Magnet**  
215

**Night**  
216

**Sphere**  
218

**N Touch**  
220



**N Tender**  
222

**Stol**  
224

**Ding**  
226

Baños  
Bath  
Salle de bains



**Lungo**  
236

**Vapor**  
238

**Clock**  
240

**Petit**  
242

Proyectores  
Spotlights  
Projecteurs



**N Keeper**  
228

**Adri**  
230



**Vitro**  
232

**Safran**  
234

Ventiladores  
Ceiling fan  
Ventilateurs  
de plafond



**N Inca**  
246

**N Helix**  
248

**N Core**  
250

**N Windy**  
252



**N Borneo**  
254, 255

**N Vera**  
256

**N Lace**  
258





**SMART**

# Forlight SMART

## Bienestar, confort y seguridad de las personas

La nueva gama de producto **Forlight Smart** está pensada para poner el foco en el bienestar de las personas, adaptando la luz a las necesidades de la estancia y del momento, y crear y transformar diferentes ambientes.

## Wellness, comfort and safety of people

The new **Forlight Smart** product range is designed to focus on people's well-being, by adapting the lighting to the room's needs and the moment, while creating and transforming different settings.

## Bien-être, confort et sécurité des personnes

La nouvelle gamme de produits **Forlight Smart** est conçue pour mettre l'accent sur le bien-être des personnes, en adaptant la lumière aux besoins de la pièce et du moment, de manière à créer et transformer différentes ambiances.

### LIGHTFORLIFE APP

Conecta tus luminarias **Forlight** a la App móvil **LightForLife**, y crea el ambiente que necesites para cada momento.

Connect your **Forlight** light fixtures to the **LightForLife** mobile app, and set the mood needed at any moment.

Reliez vos luminaires **Forlight** à l'application mobile **LightForLife**, puis créez l'ambiance nécessaire à chaque moment.



SIRI



ALEXA



GOOGLE ASSISTANT



### BENEFICIOS



**Luz confortable y adaptable.** Permite adaptar la luz a cada momento: una iluminación cálida por la noche para ayudar a la relajación y una atmósfera neutra o fría a mediodía que nos estimula para estar más activos.



**Ahorro energético.** Con la ayuda de la tecnología podemos optimizar el uso de la energía para reducir su consumo: crea escenas, horarios, modo "vacaciones", etc.



**Experiencia óptima.** De fácil instalación y uso, cualquier miembro de la familia puede controlar la iluminación desde cualquier punto de la casa o del exterior.



**Integración con otros sistemas.** Posibilidad de control por voz con Siri, Amazon Alexa y Google Assistant.

### ADVANTAGES

**Comfortable, adaptable lighting.** The light can be adapted to suit each moment: warm lighting at night to help you relax and a neutral or cool atmosphere at midday that stimulates the body to be more active.

**Energy savings.** With the help of technology, you can optimise energy usage to reduce power consumption: create scenes, timetables, "holiday" mode, etc.

**Optimal experience.** Easy to install and use, any family member can control the lighting from anywhere in the house or outside.

**Integration with other systems.** Voice control option with Siri, Amazon Alexa and Google Assistant.

### BIENFAITS

**Lumière confortable et adaptable.** Permet d'adapter la lumière à chaque moment : un éclairage chaud la nuit pour contribuer à la relaxation et une atmosphère neutre ou froide le midi pour nous stimuler afin d'être plus actifs.

**Économies d'énergie.** Avec l'aide de la technologie, on peut optimiser l'utilisation de l'énergie pour en réduire la consommation : création de scènes, horaires, mode « vacances », etc.

**Expérience optimale.** Grâce à sa facilité d'installation et d'utilisation, n'importe quel membre de la famille peut contrôler l'éclairage de n'importe quel endroit de la maison ou de l'extérieur.

**Intégration avec d'autres systèmes.** Possibilité de contrôle par la voix avec Siri, Amazon Alexa et Google Assistant.



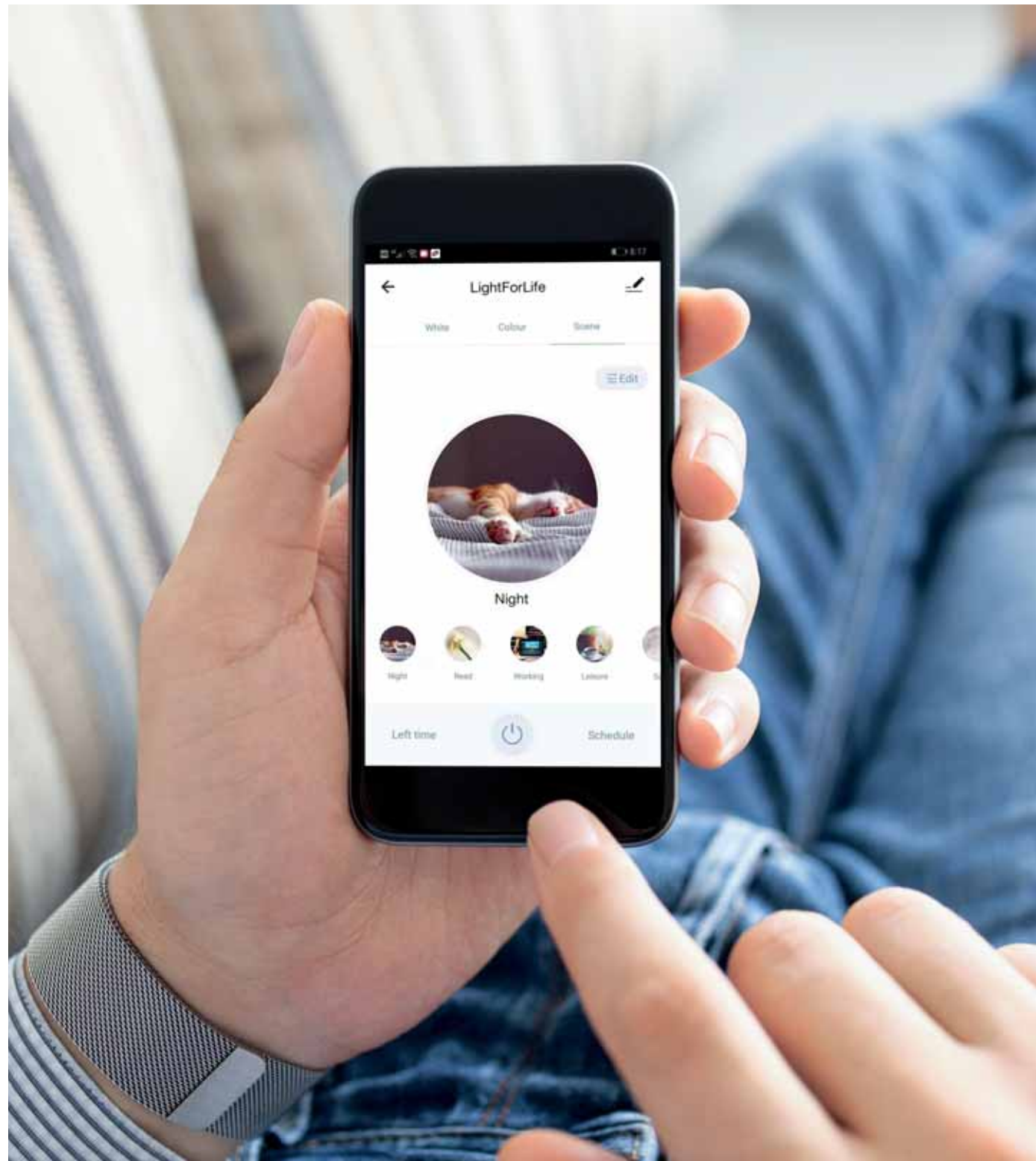

### ¿CÓMO FUNCIONA?

1. Instala la luminaria según las instrucciones.
2. Abre la **App LightForLife**.  
¡Asegúrate que estás conectado al Wi-Fi!
3. Busca la luminaria en la APP y sincronízala siguiendo las instrucciones.
4. ¡Empieza a experimentar!

### HOW DOES IT WORK?

1. Install the luminaire as instructed
2. Open the **App LightForLife**.  
Make sure you are connected to the Wi-Fi!
3. Find the luminaire in the app and synchronise it as instructed.
4. Start experimenting!

### COMMENT ÇA FONCTIONNE?

1. Installez le luminaire selon les instructions.
2. Ouvrez l'**App LightForLife**.  
Assurez-vous d'être connecté(e) au Wi-Fi!
3. Cherchez le luminaire sur l'application et synchronisez-le en suivant les consignes.
4. Commencez à expérimenter!

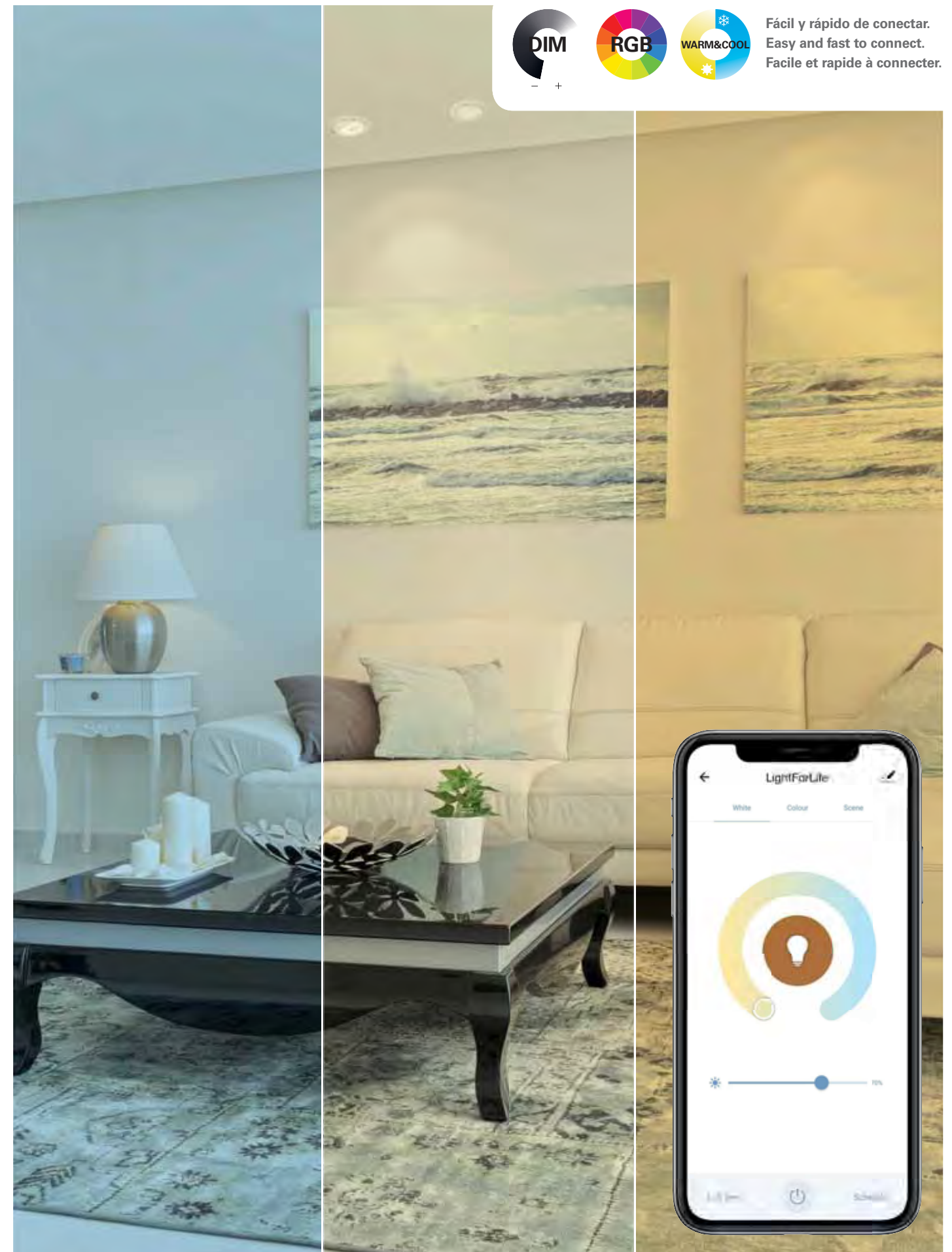





★

Ejemplo de aplicación de la **Mix Visual Comfort TC-0200-BLA****Mix Visual Comfort** application example **TC-0200-BLA**Exemple d'application du **Mix Visual Comfort TC-0200-BLA****Mix** NEW

MAT Aluminio  
Aluminium  
Aluminium

DIF Cristal  
Glass  
Verre

Blanco mate  
White matt  
Blanc mat

★

Mix es un módulo LED que requiere uno de los marcos, a escoger en la página 44.

Mix is a LED module that needs one of the frames, which you can choose from page 44.

Mix est un module LED qui exige l'un des cadres, à choisir à la page 44.

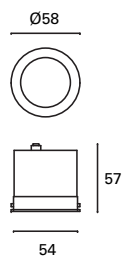
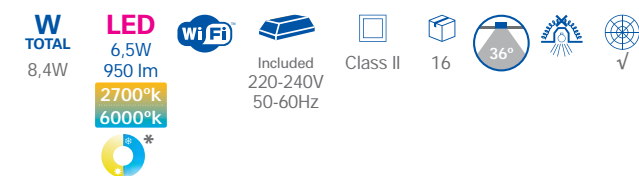
**TC-0511-BLA** ○

★

Disponibles versión de empotrar (p. 44).

Recessed version available (p. 44).

Version encastrée disponibles (p. 44).

\* **WARM&COOL:** Permite ajustar la intensidad y la temperatura de color de la luz desde blanco cálido hasta blanco frío. Allows you to adjust the light intensity and colour temperature, from warm white to cool white. Permet de régler l'intensité et la température de couleur de la lumière, du blanc chaud au blanc froid

**Hide** NEW

MAT Aluminio  
Aluminium  
Aluminium

DIF Cristal  
Glass  
Verre

Blanco mate  
White matt  
Blanc mat

★

Efecto bóveda con LED indirecto.

Vault effect with indirect LED.

Effet de dôme avec LED indirecte.

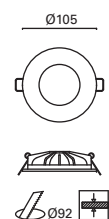
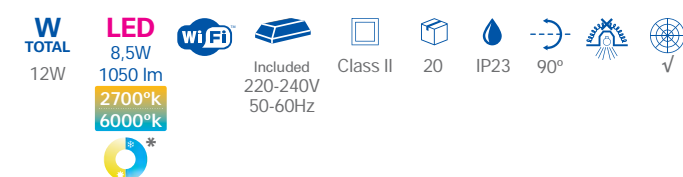
**TC-0512-BLA** ○

\* **WARM&COOL:** Permite ajustar la intensidad y la temperatura de color de la luz desde blanco cálido hasta blanco frío. Allows you to adjust the light intensity and colour temperature, from warm white to cool white. Permet de régler l'intensité et la température de couleur de la lumière, du blanc chaud au blanc froid



Easy <sup>NEW</sup>

- MAT** Aluminio  
Aluminium  
Aluminium
- DIF** Tecnopolímero  
Technopolymer  
Technopolymère
- Blanco mate  
White matt  
Blanc mat
- Gris  
Grey  
Gris

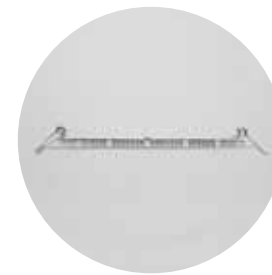

- \*  
Diseño ultra fino.  
Ultra-thin design.  
Design ultra-fin.



TC-0494-BLA ○

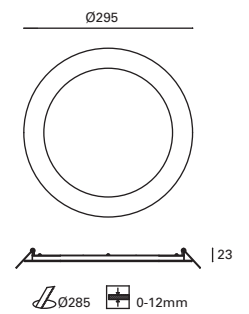
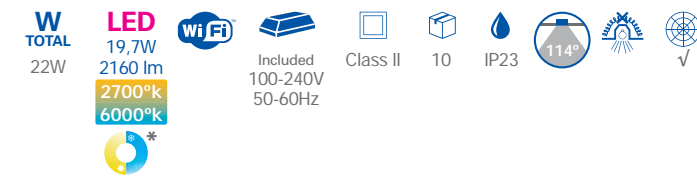

TC-0495-BLA ○

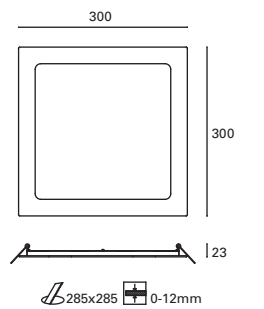
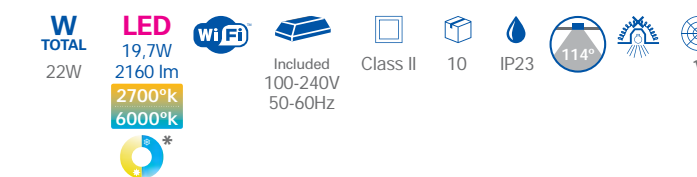

- \*  
Distribución homogénea  
del flujo lumínico.  
Homogeneous light  
distribution.  
La répartition de la lumière  
est homogène.

\* **WARM&COOL:** Permite ajustar la intensidad y la temperatura de color de la luz desde blanco cálido hasta blanco frío. Allows you to adjust the light intensity and colour temperature, from warm white to cool white. Permet de régler l'intensité et la température de couleur de la lumière, du blanc chaud au blanc froid

# Olra NEW

- MAT Acero Steel Acier
- DIF Acrílico Opal Opal Acrylic Opal acrylique
- Blanco White Blanc



DE-0513-BLA ○

<b>W</b> TOTAL 24,2W	<b>LED</b> 21W 2160 lm 2700°k 6000°k	<b>WiFi</b>	Included 230V 50-60Hz	Class II	10	IP20	✓
----------------------------	--	-------------	-----------------------------	----------	----	------	---

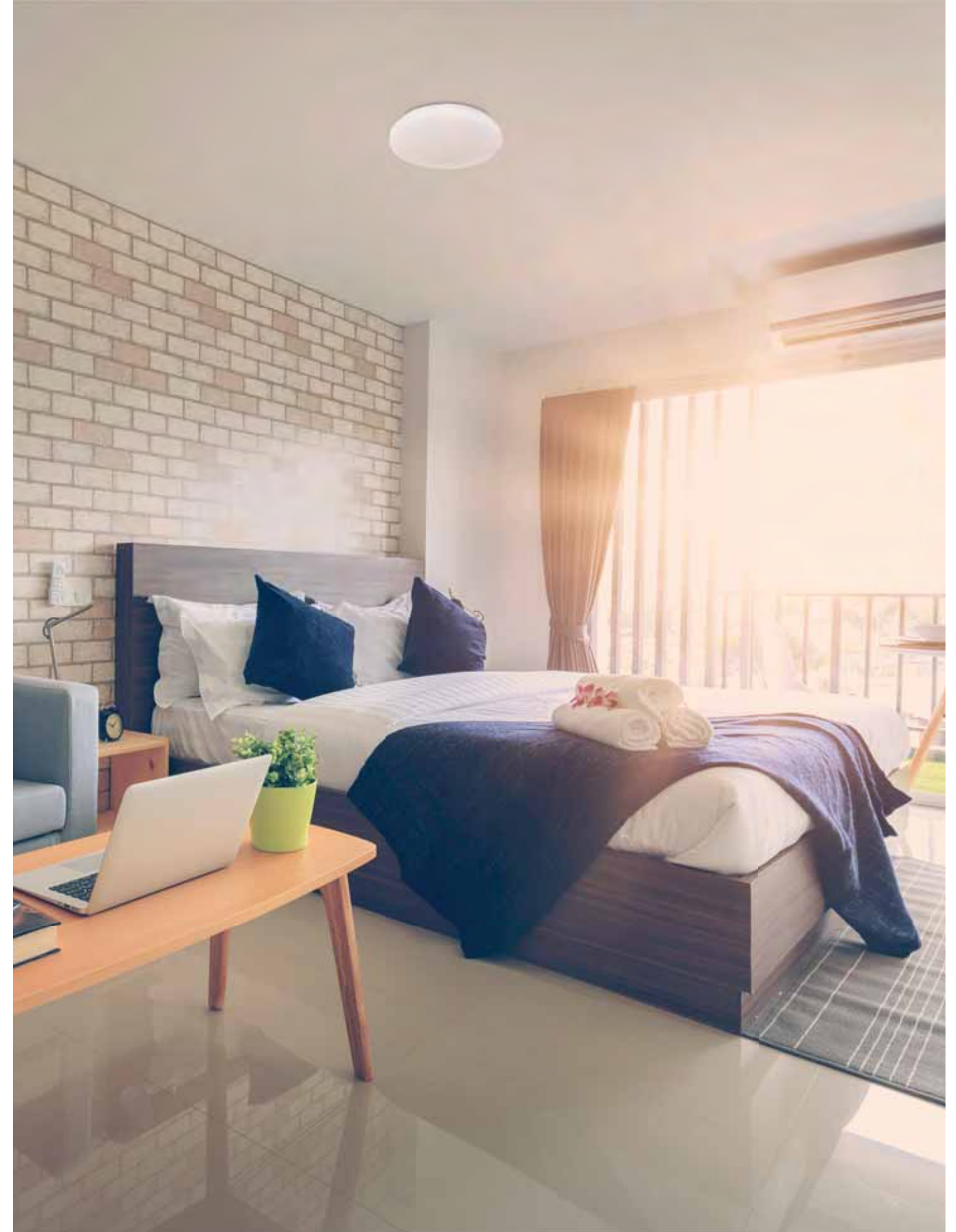
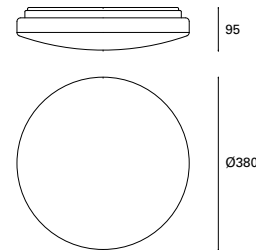

\* **WARM&COOL:** Permite ajustar la intensidad y la temperatura de color de la luz desde blanco cálido hasta blanco frío. Allows you to adjust the light intensity and colour temperature, from warm white to cool white. Permet de régler l'intensité et la température de couleur de la lumière, du blanc chaud au blanc froid



# Smart Outdoor Lighting NEW



**MAT** Polycarbonato + ABS  
Polycarbonate + ABS  
Polycarbonate + ABS

**DIF** Polycarbonato mate  
Polycarbonate matt  
Polycarbonate mat

**●** Gris urbano  
Urban grey  
Gris urbain



**PX-0514-ANT ●**

**W TOTAL** 4W  
**LED** 4W  
 410 lm  
 2700°k  
 6000°k  
 \* RGB

Included 220-240V  
 50-60Hz

Class II 12 IP65 IK10 ✓

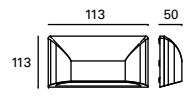

**MAT** Aluminio  
Aluminium  
Aluminium

**DIF** Polycarbonato opal  
Opal Polycarbonate  
Polycarbonate opal

**●** Gris urbano  
Urban grey  
Gris urbain



**PX-0515-ANT ●**

**W TOTAL** 3W  
**LED** 3W  
 310 lm  
 2700°k  
 6000°k  
 \* RGB

Included 220-240V  
 50-60Hz

Class II 4 IP54 IK10 ✓

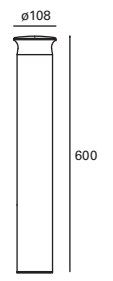

**MAT** Polycarbonato + ABS  
Polycarbonate + ABS  
Polycarbonate + ABS

**DIF** Polycarbonato transparente  
Transparent polycarbonate  
Polycarbonate transparent

**●** Negro  
Black  
Noir



**PX-0516-NEG ●**

**W TOTAL** 4W  
**LED** 4W  
 410 lm  
 2700°k  
 6000°k  
 \* RGB

Included 220-240V  
 50-60Hz

Class II 16 IP65 IK10 Sea Side Suitable 90° Included ✓

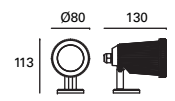

\* **WARM&COOL:** Permite ajustar la intensidad y la temperatura de color de la luz desde blanco cálido hasta blanco frío. Allows you to adjust the light intensity and colour temperature, from warm white to cool white. Permet de régler l'intensité et la température de couleur de la lumière, du blanc chaud au blanc froid





**Técnico**  
**Technical**  
**Technique**



## Onyx

MAT Aluminio  
Aluminium  
Aluminium

DIF Cristal  
Glass  
Verre

Blanco mate  
White matt  
Blanc mat

Negro  
Black  
Noir



TC-0357-BLA ○  
TC-0357-NEG ●

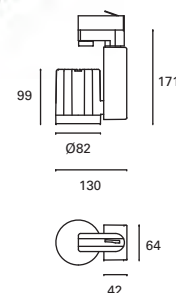

**W**  
TOTAL  
21W

**LED**  
20W  
2000 lm  
3000°K



**V/Hz**  
100-240V  
50-60Hz



12



355°



355°



\*

Compatible con carril trifásico.  
Alto rendimiento lumínico.  
No compatible con TC-0473-BLA.

Compatible with triple Phase Track.  
High luminous efficiency.  
Not compatible with TC-0473-BLA.

Compatible avec rail triphasé.  
Grande efficacité lumineuse  
Non compatible avec TC-0473-BLA.



TC-0358-BLA ○  
TC-0358-NEG ●

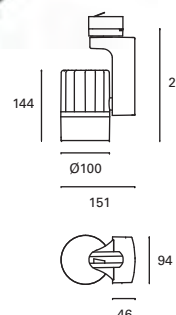

**W**  
TOTAL  
38,5W

**LED**  
35W  
4000 lm  
3000°K



**V/Hz**  
100-240V  
50-60Hz



8



355°



355°



## Iko

Aluminio  
Aluminium  
AluminiumPolicarbonato  
Polycarbonate  
PolycarbonateBlanco  
White  
BlancNegro  
Black  
NoirTC-0425-BLA ○  
TC-0425-NEG ●W  
TOTAL  
28,2WLED  
25W  
2520 lm  
3000°K

Included

V/Hz  
100-240V  
50-60Hz

Class I

8

30°

355°

355°

✓

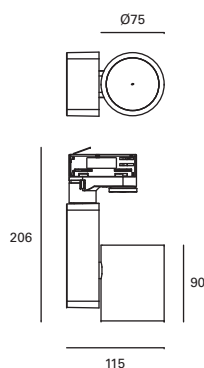



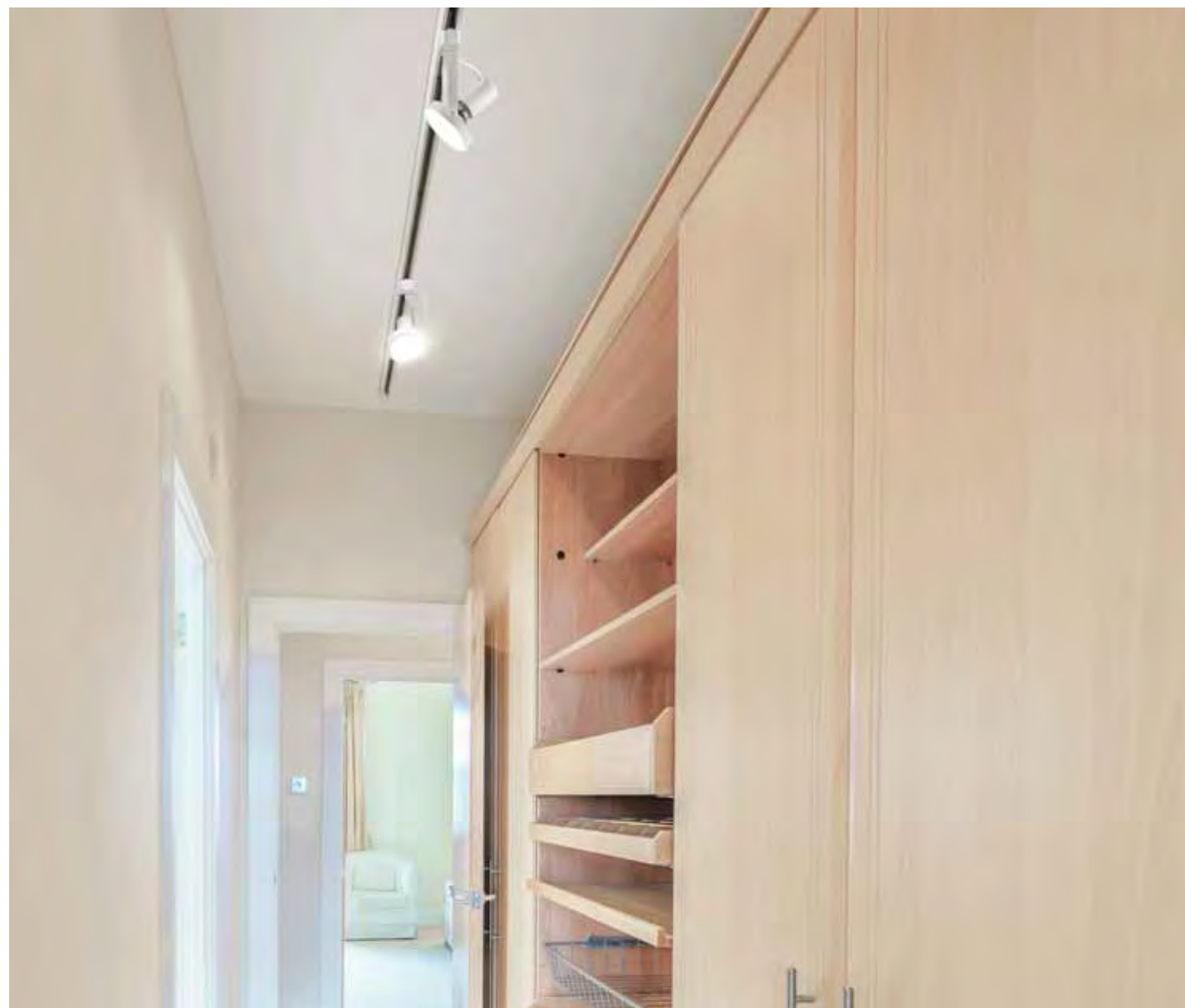

## Kyo



Aluminio  
Aluminium  
Aluminium



Blanco mate  
White matt  
Blanc mat



Compatible con carril monofásico  
(TC-0437-BLA).  
Proyector PAR-30 LED.

Compatible with single Phase Track.  
(TC-0437-BLA).  
PAR-30 LED spotlight.

Compatible avec rail monophasé.  
(TC-0437-BLA).  
Projecteur PAR-30.



**TC-0360-BLA** ○

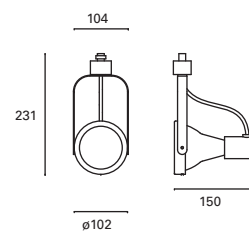

## Cone



Acero  
Steel  
Acier



Blanco mate  
White matt  
Blanc mat



Compatible con carril monofásico  
(TC-0437-BLA).  
Proyector PAR-30 LED.

Compatible with single Phase Track.  
(TC-0437-BLA).  
PAR-30 LED spotlight.

Compatible avec rail monophasé.  
(TC-0437-BLA).  
Projecteur PAR-30.



**TC-0316-BLA** ○

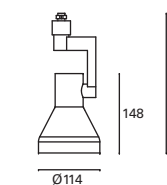
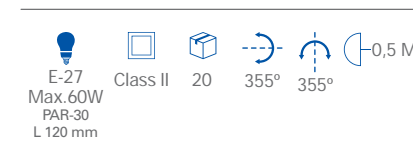

## Key

MAT Aluminio  
Aluminium  
Aluminium

Blanco  
White  
Blanc

Negro  
Black  
Noir



TC-0484-BLA ○  
TC-0484-NEG ●

GU10  
AR-111  
Max. 15W  
Ø 110 mm

V/Hz  
100-240V  
50-60Hz

Class I

12

355°

355°

0,5 M

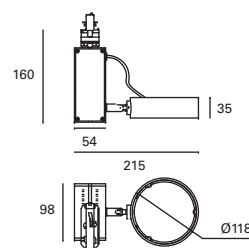

Compatible con carril trifásico.  
No compatible con TC-0473-BLA.

Compatible with triple Phase Track.  
Not compatible with TC-0473-BLA.

Compatible avec rail triphasé.  
Non compatible avec TC-0473-BLA.



TC-0485-BLA ○  
TC-0485-NEG ●

GU10  
Max. 75W  
Ø 50 mm

V/Hz  
100-240V  
50-60Hz

Class I

12

355°

90°

0,5 M

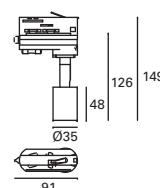



## Elit

MAT Aluminio  
Aluminium  
Aluminium

DIF Cristal  
Glass  
Verre

Blanco mate  
White matt  
Blanc mat



TC-0306-BLA ○

**W**  
TOTAL  
7,3W

**LED**  
5,6W  
470 lm  
3000°K



Included

**V/Hz**  
100-240V  
50-60Hz



Class II



20



60°



355°



90°



√

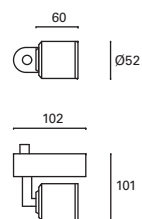

Compatible con carril monofásico (TC-0473-BLA).  
Pieza compacta ideal techos bajos.

Compatible with single PhaseTrack (TC-0473-BLA).  
Compact piece perfect for low ceilings.

Compatible avec rail monophasé (TC-0473-BLA).  
Pièce compacte parfaite pour toits bas.



## Accessory

MAT Policarbonato  
Polycarbonate  
Polycarbonate

Blanco  
White  
Blanc



**TC-0473-BLA** ○

Carril monofásico + Tapa final + Acometida  
Single-phase track + End cap + Mains connector  
Rail monophasé + Cache final + Connecteur d'alimentation



10

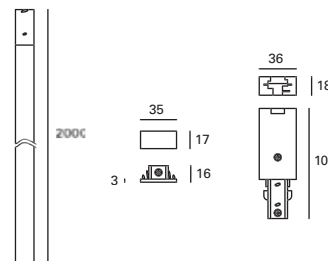

**TC-8003-BLA** ○

Conector continuidad  
Straight connector  
Connecteur de continuité



10

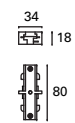

**TC-8004-BLA** ○

Conector en "L"  
"L" connector  
Connecteur "L"



5

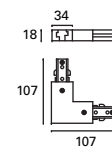

## Tub

MAT Aluminio  
Aluminium  
Aluminium

DIF Cristal  
Glass  
Verre

Blanco mate  
White matt  
Blanc mat



○ 3000°k  
○ 4000°k  
**TC-0131-BLA** ○  
**TC-0217-BLA** ○

**W**  
TOTAL  
7,1W

**LED**  
5,8W  
530 lm

Included  
100-240V  
50-60Hz

Class II

25

IP23

60°

✓

Ø53



149



○ 4000°k  
**TC-0218-BLA** ○

**W**  
TOTAL  
15,7W

**LED**  
12,6W  
1140 lm

Included  
100-240V  
50-60Hz

Class II

25

IP23

60°

✓

Ø76



188



Ángulo de 60°.  
Beam angle 60°.  
Angle de 60°.

**Fox** NEW

MAT Aluminio  
Aluminium  
Aluminium

DIF Policarbonato  
Polycarbonate  
Polycarbonate

Blanco  
White  
Blanc



TC-0499-BLA ○

**W TOTAL** 8,8W  
**LED** 7,9W  
670 lm  
3000°K

Included

**V/Hz** 100-240V  
50-60Hz

Class II

8

36°

340°

90°

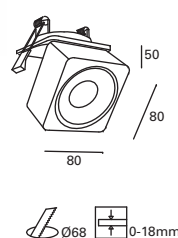

TC-0498-BLA ○

**W TOTAL** 8,8W  
**LED** 7,9W  
670 lm  
3000°K

Included

**V/Hz** 100-240V  
50-60Hz

Class II

8

36°

340°

90°

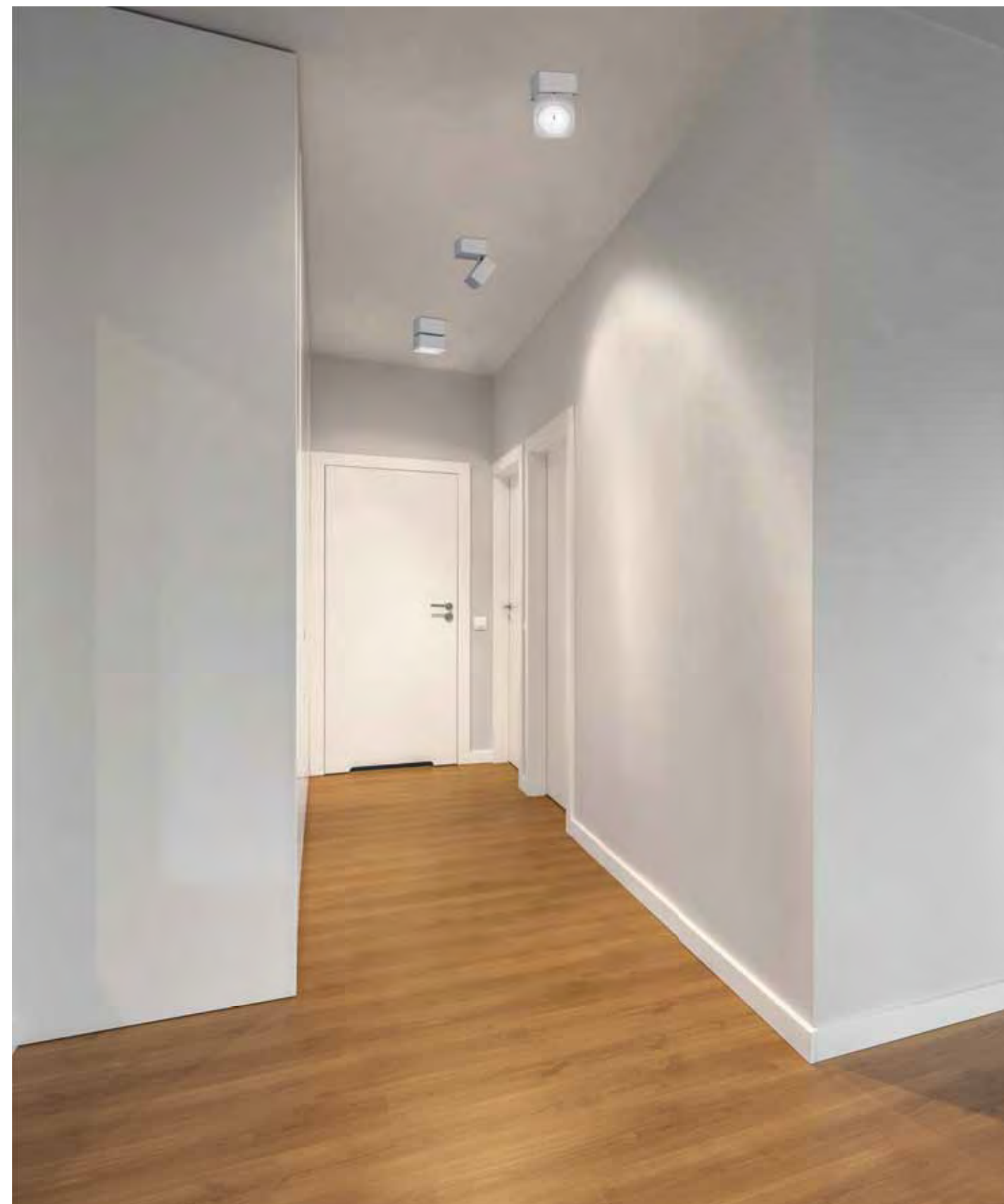
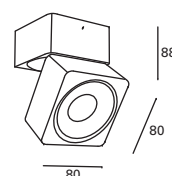

\*  
Máximo confort visual.  
Complete visual comfort.  
Confort visuel optimal.



# Mix

MAT Aluminio  
Aluminium  
Aluminium

DIF Cristal  
Glass  
Verre

Blanco mate  
White matt  
Blanc mat



**TC-1700-BLA** ○ 3000°k  
**TC-0219-BLA** ○ 4000°k

**W TOTAL** 7W **LED** 6W 580 lm  
Included 100-240V 50-60Hz  
Class II 16 36°



**TC-0511-BLA** ○

**W TOTAL** 8,4W **LED** 6,5W 1510 lm  
2700°k 6000°k  
Included 220-240V 50-60Hz  
Class II 16 36°



\*  
No compatible  
con TC-0305-BLA.  
Not compatible  
with TC-0305-BLA.  
Non compatible  
avec TC-0305-BLA.



**TC-0471-BLA** ○ 220-240V / 50-60Hz  
**TC-0422-BLA** ○ 100-240V / 50-60Hz

**W TOTAL** 11,8W **LED** 10W 1170 lm  
3000°k  
Class II 16 36°



**TC-0366-BLA** ○

**V/Hz** 100-240V 50-60Hz  
Class II 50  
GU10 Max. 7W  
Not included L 55 mm - Ø 50 mm

**TC-0511-BLA**  
**TC-1700-BLA**  
**TC-0219-BLA**

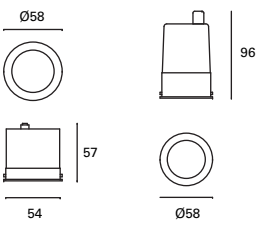

**TC-0366-BLA**



FIXED

ROUND ADJUSTABLE

DEEP

VISUAL COMFORT

VISUAL COMFORT ADJUSTABLE

IP65

FIRE RATED



**TC-1900-BLA** ○

IP54 100  
Ø81  
37 57  
Ø70 0-20mm



**TC-1901-BLA** ○

IP23 20° 100  
Ø95  
34 57  
Ø82 0-20mm



**TC-0476-BLA** ○

IP23 100  
42 91  
Ø75 0-30mm



**TC-0200-BLA** ○

IP54 100  
Ø80  
38 71  
Ø74 0-25mm



**TC-0303-BLA** ○

IP23 50  
Ø94  
49 73  
Ø85 0-30mm



**TC-0220-BLA** ○

IP65 50  
Ø96  
37 77  
Ø75 0-30mm



**TC-0305-BLA** ○

IP23 60° 50  
Ø94  
Ø66 99  
Ø80 0-20mm



**TC-0304-BLA** ○

20° 25  
Ø80  
162



\* **WARM&COOL:** Permite ajustar la intensidad y la temperatura de color de la luz desde blanco cálido hasta blanco frío. Allows you to adjust the light intensity and colour temperature, from warm white to cool white. Permet de régler l'intensité et la température de couleur de la lumière, du blanc chaud au blanc froid



## Hide

MAT  
Aluminio  
Aluminium  
Aluminium

DIF  
Cristal  
Glass  
Verre

Blanco mate  
White matt  
Blanc mat



TC-0175-BLA ○ 3000°k  
TC-0215-BLA ○ 4000°k

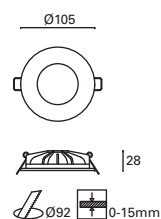
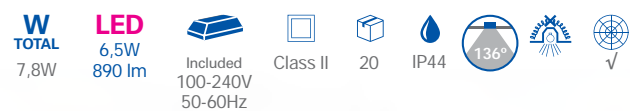

TC-0176-BLA ○ 3000°k  
TC-0216-BLA ○ 4000°k

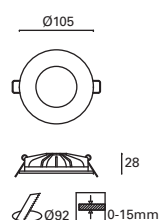
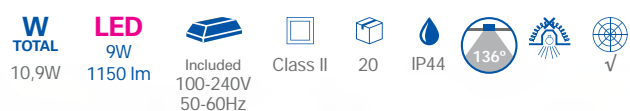

N TC-0512-BLA ○

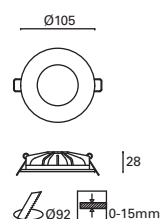
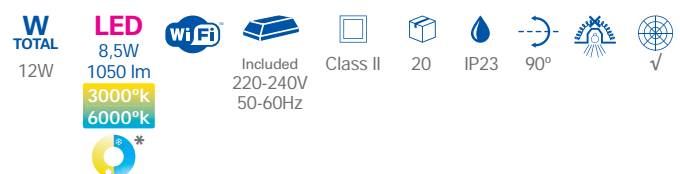

Efecto bóveda con LED indirecto.  
Vault effect with indirect LED.  
Effet de dôme avec LED indirecte.

\* WARM&COOL: Permite ajustar la intensidad y la temperatura de color de la luz desde blanco cálido hasta blanco frío. Allows you to adjust the light intensity and colour temperature, from warm white to cool white. Permet de régler l'intensité et la température de couleur de la lumière, du blanc chaud au blanc froid





## Minor

MAT Aluminio  
Aluminium  
Aluminium

DIF Cristal  
Glass  
Verre

Blanco mate  
White matt  
Blanc mat

Cromo satinado  
Satin chrome  
Chrome satiné



TC-1200-BLA ○  
TC-1200-SAT ●

- GU10 Max.50W Ø 50 mm
- GU5.3 Max.50W
- Not included 12V AC / 50-60Hz
- V/Hz 100-240V 50-60Hz
- 50
- IP54
- 0,5 M
- Class II
- Class III

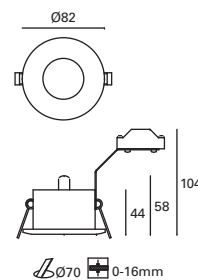

\*  
Apto para baños.  
Suitable for bathrooms.  
Convient pour salles  
de bains.

## Top

MAT Aluminio  
Aluminium  
Aluminium

DIF Policarbonato  
Polycarbonate  
Polycarbonate

Blanco mate  
White matt  
Blanc mat



TC-0489-BLA ○

- W TOTAL 7,8W
- LED 6,6W 615 lm 3000°k
- Included
- V/Hz 100-240V 50-60Hz
- Class II
- 10
- IP54
- 42°
- Class II

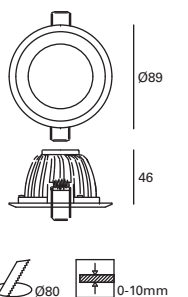

\*  
Apto para baños.  
Suitable for bathrooms.  
Convient pour salles  
de bains.



## Sound Plus

MAT  
Aluminio  
Aluminium  
Aluminium

Blanco mate  
White matt  
Blanc mat



TC-0134-BLA ○

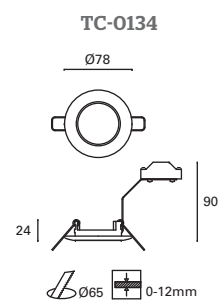

TC-0135-BLA ○

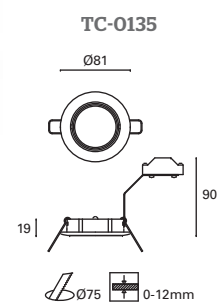

\*

Estructura de aluminio macizo.  
Solid aluminum structure.  
Structure en aluminium solide.





# Bala



Aluminio  
Aluminium  
Aluminium



Policarbonato  
Polycarbonate  
Polycarbonate



Blanco  
White  
Blanc



**FIRE RATE**



Lente para un perfecto control óptico

Lens for perfect optical control

Lentille pour un parfait contrôle optique

**TC-0440-BLA** ○

<b>W TOTAL</b> 5,2W	<b>LED</b> 4,5W 510 lm 3000°K	Phase cut	Included	<b>V/Hz</b> 220-240V 50-60Hz	Class II	20	IP65	60°		
------------------------	--	-----------	----------	------------------------------------	----------	----	------	-----	--	--

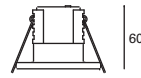

Ø57 0-35mm



**FIRE RATE**

**TC-0472-BLA** ○ 3000°K  
**TC-0491-BLA** ○ 2700°K

<b>W TOTAL</b> 8,9W	<b>LED</b> 7,6W 850 lm	Phase cut	Included	<b>V/Hz</b> 220-240V 50-60Hz	Class II	20	IP65	60°		
------------------------	------------------------------	-----------	----------	------------------------------------	----------	----	------	-----	--	--

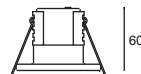

Ø57 0-35mm



Apto para baños  
Suitable for bathrooms  
Convient pour salles de bains



## Easy

Aluminio  
Aluminium  
AluminiumTecnopolímero  
Technopolymer  
TechnopolymèreBlanco mate  
White matt  
Blanc matGris  
Grey  
GrisDiseño ultra fino.  
Ultra-thin design.  
Design ultra-fin.

TC-0146-BLA 3000°k  
 TC-0146-GRI 3000°k  
 TC-0147-BLA 4000°k  
 TC-0147-GRI 4000°k  
 TC-0460-BLA 6000°k  
 TC-0460-GRI 6000°k

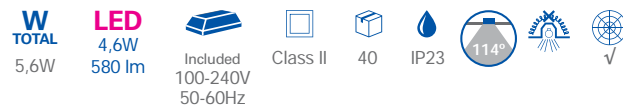

TC-0148-BLA 3000°k  
 TC-0148-GRI 3000°k  
 TC-0149-BLA 4000°k

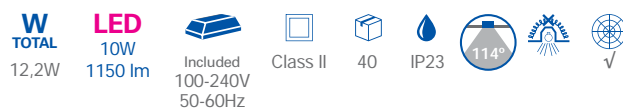

TC-0150-BLA 3000°k  
 TC-0150-GRI 3000°k  
 TC-0151-BLA 4000°k

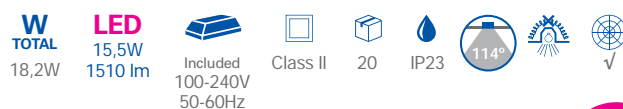

TC-0494-BLA

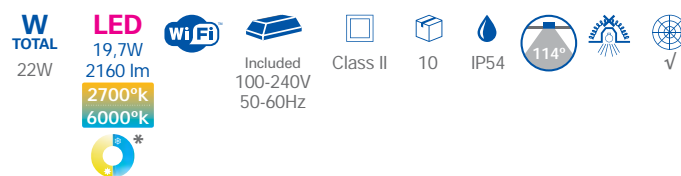

TC-0203-BLA 3000k  
 TC-0204-BLA 4000k

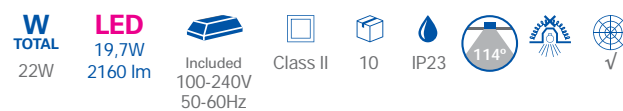
Distribución homogénea  
del flujo lumínico.  
Homogeneous light  
distribution.  
La répartition de la lumière  
est homogène.

TC-0146 / TC-0147 / TC-0460

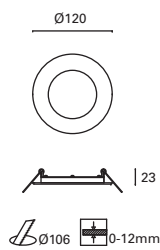

TC-0148 / TC-0149

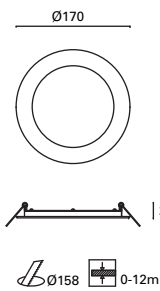

TC-0150 / TC-0151 / TC-0494

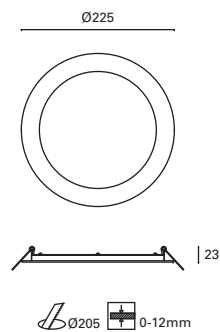

TC-0203 / TC-0204

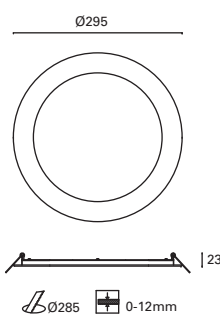
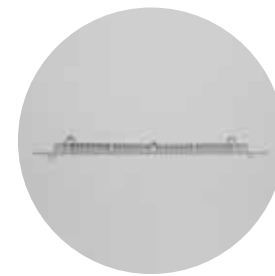
Aluminio  
Aluminium  
AluminiumTecnopolímero  
Technopolymer  
TechnopolymèreBlanco mate  
White matt  
Blanc matGris  
Grey  
GrisDiseño ultra fino.  
Ultra-thin design.  
Design ultra-fin.

TC-0152-BLA 3000°k  
 TC-0152-GRI 3000°k  
 TC-0153-BLA 4000°k  
 TC-0153-GRI 4000°k  
 TC-0461-BLA 6000°k  
 TC-0461-GRI 6000°k

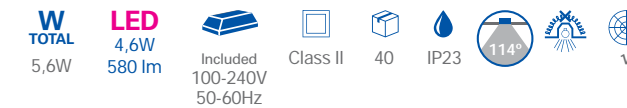

TC-0154-BLA 3000°k  
 TC-0154-GRI 3000°k  
 TC-0155-BLA 4000°k

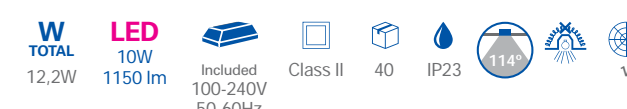

TC-0156-BLA 3000°k  
 TC-0156-GRI 3000°k  
 TC-0157-BLA 4000°k

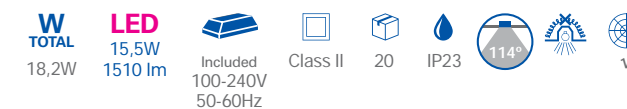

TC-0495-BLA

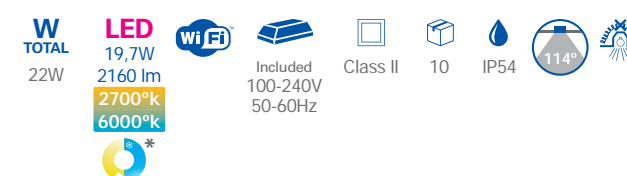

TC-0212-BLA 3000k  
 TC-0213-BLA 4000k

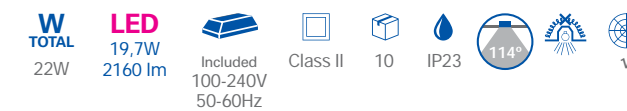
Distribución homogénea  
del flujo lumínico.  
Homogeneous light  
distribution.  
La répartition de la lumière  
est homogène.

TC-0152 / TC-0153 / TC-0461

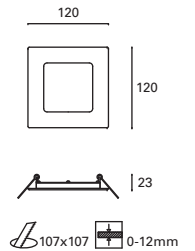

TC-0154 / TC-0155

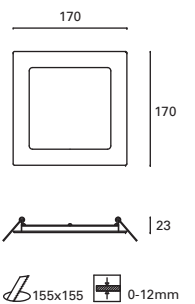

TC-0156 / TC-0157 / TC-0495

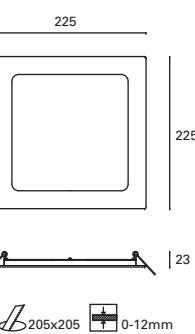

TC-0212 / TC-0213

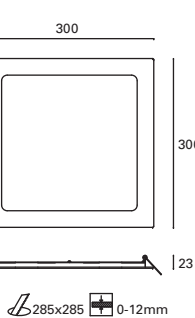





## Easy Surface

- MAT Aluminio  
Aluminium  
Aluminium
- DIF Tecnopolímero  
Technopolymer  
Technopolymère
- Blanco mate  
White matt  
Blanc mat



TC-0158-BLA 3000°k  
 TC-0159-BLA 4000°k  
 TC-0462-BLA 6000°k

**W TOTAL** 5,6W  
**LED** 4,6W  
 580 lm  
 Included 100-240V  
 50-60Hz  
 Class II  
 40  
 114°  
 ✓

TC-0158 / TC-0159 / TC-0462

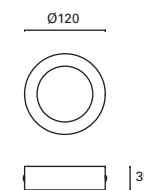

TC-0160-BLA 3000°k  
 TC-0161-BLA 4000°k

**W TOTAL** 12,2W  
**LED** 10W  
 1150 lm  
 Included 100-240V  
 50-60Hz  
 Class II  
 20  
 114°  
 ✓

TC-0160 / TC-0161

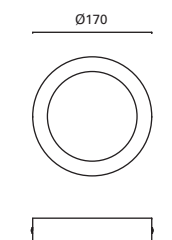

TC-0162-BLA 3000°k  
 TC-0163-BLA 4000°k

**W TOTAL** 18,2W  
**LED** 15,5W  
 1510 lm  
 Included 100-240V  
 50-60Hz  
 Class II  
 20  
 114°  
 ✓

TC-0162 / TC-0163

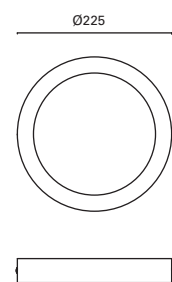

TC-0415-BLA 3000°k  
 TC-0416-BLA 4000°k

**W TOTAL** 24W  
**LED** 22W  
 2700 lm  
 Included 100-240V  
 50-60Hz  
 Class II  
 10  
 114°  
 ✓

TC-0415 / TC-0416

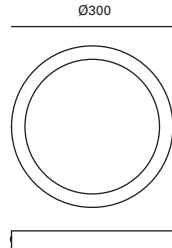

TC-0411-BLA 3000°k  
 TC-0412-BLA 4000°k

**W TOTAL** 29,3W  
**LED** 26,4W  
 3375 lm  
 Included 100-240V  
 50-60Hz  
 Class II  
 5  
 114°  
 ✓

TC-0411 / TC-0412

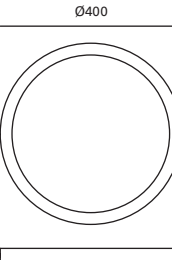

Distribución homogénea  
del flujo lumínico.

Homogeneous light distribution.

La répartition de la lumière est  
homogène.

## Easy Surface



Aluminio  
Aluminium  
Aluminium



Tecnopolímero  
Technopolymer  
Technopolymère



Blanco mate  
White matt  
Blanc mat



**TC-0164-BLA** ○ 3000°k

**TC-0165-BLA** ○ 4000°k

**TC-0463-BLA** ○ 6000°k

**W**  
TOTAL  
5,6W

**LED**  
4,6W  
580 lm



Included  
100-240V  
50-60Hz



Class II



40



114°



✓

**TC-0166-BLA** ○ 3000°k

**TC-0167-BLA** ○ 4000°k

**W**  
TOTAL  
12,2W

**LED**  
10W  
1150 lm



Included  
100-240V  
50-60Hz



Class II



20



114°



✓

**TC-0168-BLA** ○ 3000°k

**TC-0169-BLA** ○ 4000°k

**W**  
TOTAL  
18,2W

**LED**  
15,5W  
1510 lm



Included  
100-240V  
50-60Hz



Class II



20



114°



✓

**TC-0413-BLA** ○ 3000°k

**TC-0414-BLA** ○ 4000°k

**W**  
TOTAL  
28,1W

**LED**  
26,4W  
3375 lm



Included  
100-240V  
50-60Hz



Class II



5



114°



✓

TC-0164 / TC-0165 / TC-0463

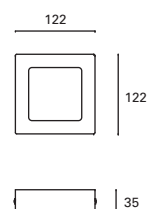

TC-0166 / TC-0167

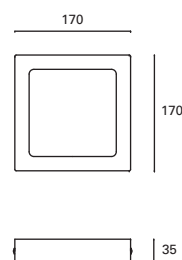

TC-0168 / TC-0169

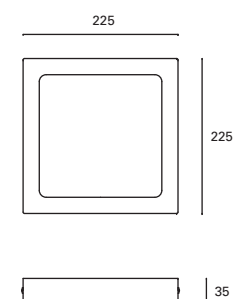

TC-0413 / TC-0414

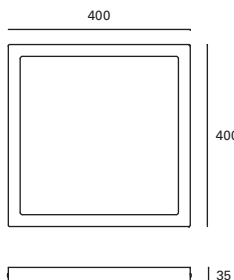

Distribución homogénea  
del flujo lumínico.

Homogeneous light distribution.

La répartition de la lumière est  
homogène.



Wide NEW

MAT Aluminio  
Aluminium  
Aluminium

DIF Policarbonato  
Polycarbonate  
Polycarbonate

Blanco  
White  
Blanc



TC-0503-BLA ○

<b>W</b> TOTAL 9,5W	<b>LED</b> 8,5W 1100 lm 3000°k	Included	<b>V/Hz</b> 100-240V 50-60Hz	Class II	40	IP54	180°	
---------------------------	---	----------	------------------------------------	----------	----	------	------	--

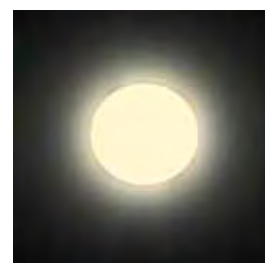

\*  
180°



TC-0504-BLA ○

<b>W</b> TOTAL 9,5W	<b>LED</b> 8,5W 1100 lm 4000°k	Included	<b>V/Hz</b> 100-240V 50-60Hz	Class II	40	IP54	180°	
---------------------------	---	----------	------------------------------------	----------	----	------	------	--

TC-0503 / TC-0504

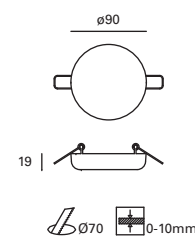

TC-0505-BLA ○

<b>W</b> TOTAL 17,4W	<b>LED</b> 16,2W 2000 lm 3000°k	Included	<b>V/Hz</b> 100-240V 50-60Hz	Class II	40	IP54	180°	
----------------------------	--	----------	------------------------------------	----------	----	------	------	--



TC-0506-BLA ○

<b>W</b> TOTAL 17,4W	<b>LED</b> 16,2W 2000 lm 4000°k	Included	<b>V/Hz</b> 100-240V 50-60Hz	Class II	40	IP54	180°	
----------------------------	--	----------	------------------------------------	----------	----	------	------	--

TC-0505 / TC-0506

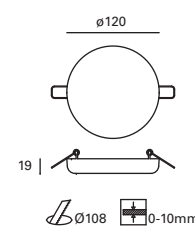

\*

Downlight sin marco que proporciona una iluminación mucho más amplia.

Frameless downlight provides much wider illumination.

Downlight sans cadre qui assure un éclairage beaucoup plus étendu.



# Square

- MAT Aluminio Aluminium Aluminium
- DIF Tecnopolímero Technopolymer Technopolymère
- Blanco mate White matt Blanc mat



TC-0202-BLA



5



Marco para versión de superficie, compatible con TC-0170-BLA y TC-0434-BLA.

Frame for surface-mounted version, compatible with TC-0170-BLA and TC-0434-BLA.

Cadre pour la version à montage en Surface, compatible avec TC-0170-BLA et TC-0434-BLA.



**TC-0170-BLA** 4000°k 4550 lm  
**TC-0434-BLA** 3000°k 4375 lm

W TOTAL 40,1W   
 LED 35,4W   
 Included 100-240V 50-60Hz   
 Class II   
 5   
 114°   

TC-0170-BLA / TC-0434-BLA

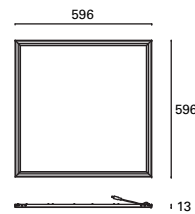

Substitución directa placas tipo armstrong  
 Directly replacing armstrong ceiling units



Compatible con el sistema de instalación Armstrong.

Compatible with Armstrong installation system.

Compatible avec le système d'installation Armstrong.

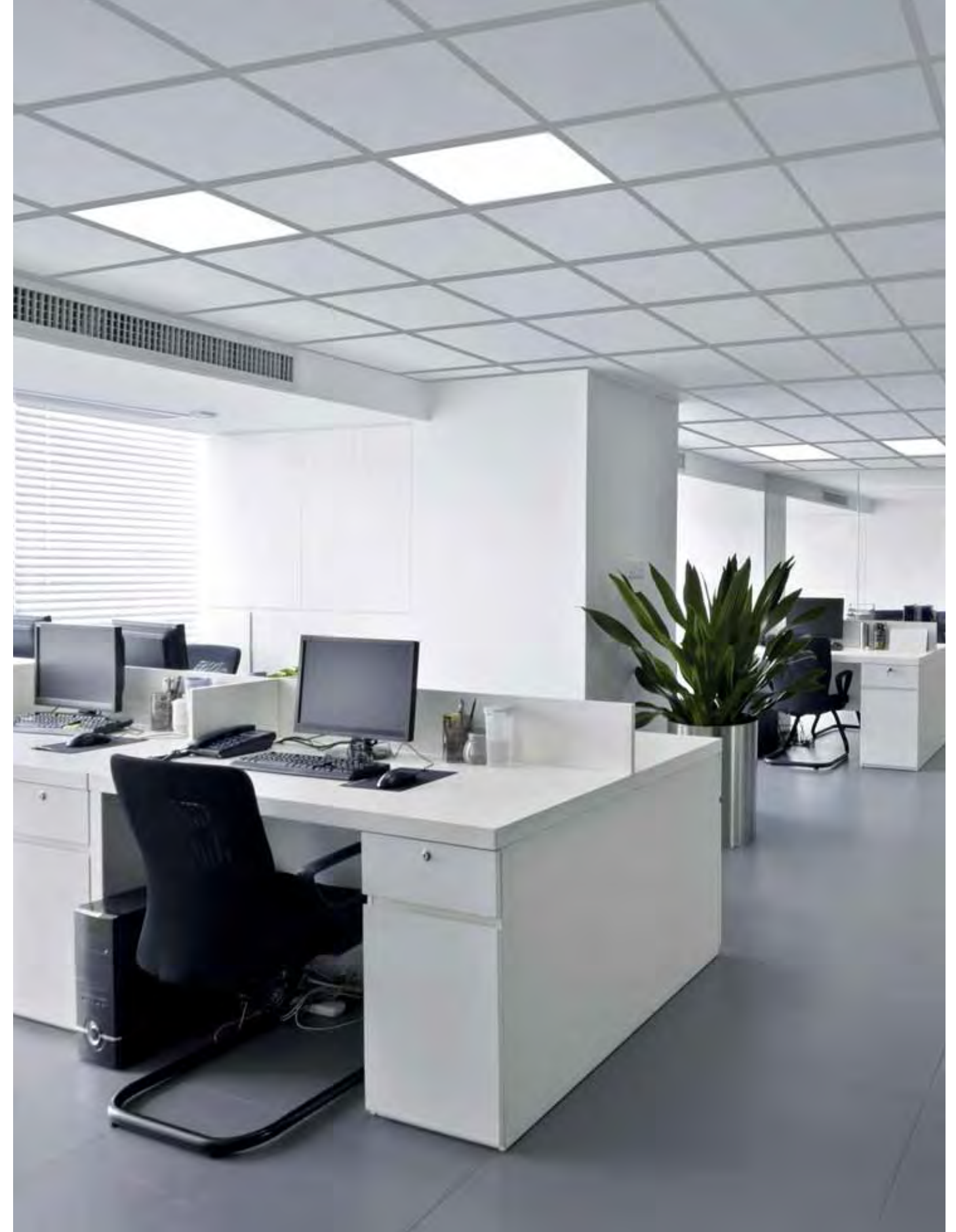



Base NEW

MAT Aluminio  
Aluminium  
Aluminium

DIF Cristal  
Glass  
Verre

Blanco  
White  
Blanc



TC-0501-BLA ○

**W**  
TOTAL  
7W

**LED**  
6,1W  
820 lm  
3000°k

Included

**V/Hz**  
100-240V  
50-60Hz

Class II

20

IP54

60°

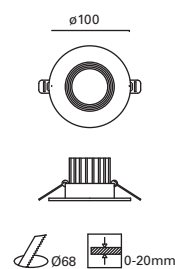

TC-0502-BLA ○

**W**  
TOTAL  
7W

**LED**  
6,1W  
820 lm  
3000°k

Included

**V/Hz**  
100-240V  
50-60Hz

Class II

20

IP23

60°

45°

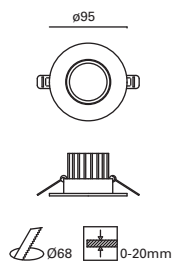

Máximo confort visual.  
Complete visual comfort.  
Confort visuel optimal.



## Dorit

MAT  
Aluminio  
Aluminium  
Aluminium

DIF  
Cristal  
Glass  
Verre

Blanco mate  
White matt  
Blanc mat



TC-0349-BLA ○

**W**  
TOTAL  
15,7W

**LED**  
14W  
1530 lm  
3000°k



**V/Hz**  
100-240V  
50-60Hz



18



Ø140

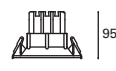

∠Ø120 0-12mm



TC-0350-BLA ○

**W**  
TOTAL  
18,7W

**LED**  
17,3W  
2300 lm  
3000°k



**V/Hz**  
100-240V  
50-60Hz



12



Ø165



∠Ø150 0-12mm



Máximo confort visual.  
Complete visual comfort.  
Confort visuel optimal.





## Cardan



Acero  
Steel  
Acier



Blanco mate  
White matt  
Blanc mat



Gris  
Grey  
Gris



TC-1400-BLA ○  
TC-1400-GRI ●

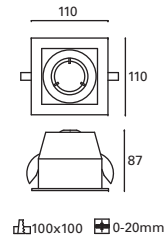
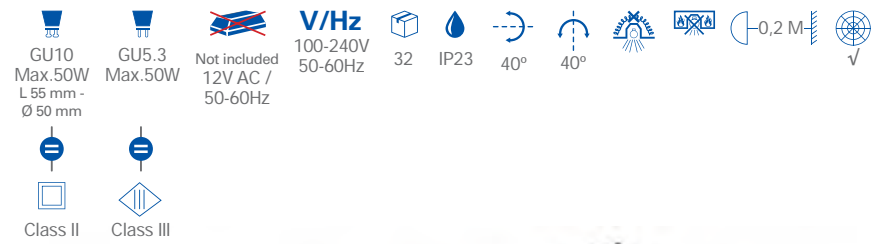

TC-1401-BLA ○

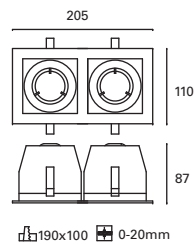
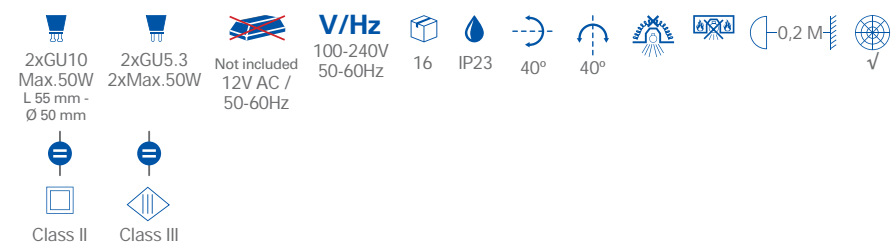

Compatible con módulo  
MIX TC-0511-BLA, TC-1700-BLA,  
TC-0219-BLA (p. 44)

Compatible with module  
MIX TC-0511-BLA, TC-1700-BLA,  
TC-0219-BLA (p. 44)

Compatible avec le module  
MIX TC-0511-BLA TC-1700-BLA,  
TC-0219-BLA (p. 44)



# Cardan

MAT

Acero  
Steel  
Acier

○

Blanco mate  
White matt  
Blanc mat

TC-1500-BLA ○

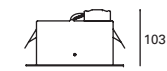
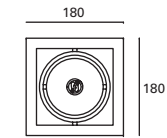
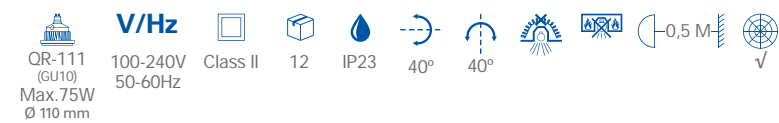

TC-0172-BLA ○

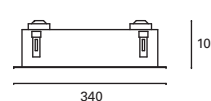
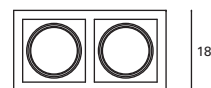
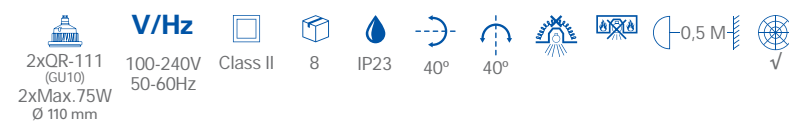



# Ilo

MAT Aluminio  
Aluminium  
Aluminium

DIF Acrílico  
Acrylic  
Acrylique

Blanco mate  
White matt  
Blanc mat

Gris  
Grey  
Gris



## UNION KIT



\*  
Kit para unir dos ILO consecutivas. No incluido.  
Kit for joining two consecutive ILO. Not included  
Kit servant à raccorder deux modèles ILO consécutifs. Non inclus.

- TC-0450-BLA ○ 3000°k
- TC-0451-BLA ○ 4000°k
- TC-0450-GRI ● 3000°k
- TC-0451-GRI ● 4000°k

**W TOTAL** 27,9W  
**LED** 25W 2635 lm  
Included  
**V/Hz** 100-240V 50-60Hz  
Class I  
6  
√

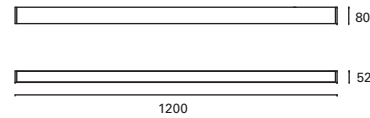

TC-0454-SIN

6

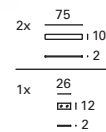

## PENDANT KIT



TC-0452-BLA ○  
TC-0452-GRI ●

Class I  
6

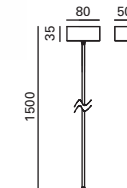

TC-0453-SIN

6

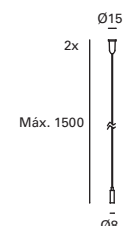

\*  
Accesorios colgantes no incluidos. Ambos necesarios.  
Hanging accessories not included. Both necessary.  
Accessoires de suspension non inclus. Les deux nécessaires.

A dark, futuristic interior with blue lighting. The scene features a staircase on the left side, with several small, glowing blue oval-shaped lights embedded in the wall above it. The overall atmosphere is mysterious and high-tech.

**Exterior**  
**Outdoor**  
**Extérieur**



## Ringo

MAT Acero inoxidable AISI 304  
Stainless steel AISI 304  
Acier inoxydable AISI 304

DIF Cristal  
Glass  
Verre

Acero inoxidable  
Stainless steel  
Acier inoxydable



PX-0128-INO ● 3000°k 370 lm  
PX-0123-INO ● 4000°k 420 lm

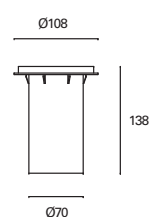
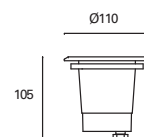

Máxima protección del LED  
contra la intemperie mediante  
silicona.

Maximum weather protection  
in the LED thanks to silicone.

Protection contre les intempéries  
maximale grâce à la silicone.



PX-0355-INO ● 3000°k

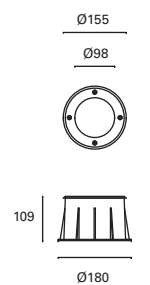



## Ringo

MAT Acero inoxidable AISI 304  
Stainless steel AISI 304  
Acier inoxydable AISI 304

DIF Cristal  
Glass  
Verre

Acero inoxidable  
Stainless steel  
Acier inoxydable



PX-1000-INO ●

GU10  
Max. 50W  
L 55 mm -  
Ø 50 mm

V/Hz  
100-240V  
50-60Hz

Class I

12

IP65  
IP67

IK10

0,5 M

Included

✓

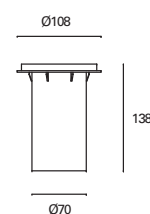
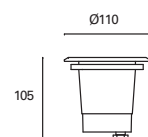

\*

Máximo rendimiento lumínico  
gracias al reflector incluido.

Maximum light efficiency thanks to  
the included reflector.

Efficacité lumineuse optimale  
grâce au projecteur inclus.

\*

Compatible con lámparas Par-30  
y Par-38.

Compatible with Par-30 and Par-38  
light bulbs.

Compatible avec ampoules Par-30  
et Par-38.

E-27  
Max. 60W  
L 150 mm -  
Ø 115 mm

V/Hz  
100-240V  
50-60Hz

Class I

8

IP65  
IP67

IK10

0,3 m

Included

✓

PX-0354-INO ●

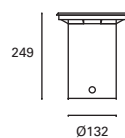
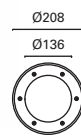



## Tidian



Tecnopolímero  
Technopolymer  
technopolymère



Cristal  
Glass  
Verre



Negro  
Black  
Noir



PX-1100-NEG ●

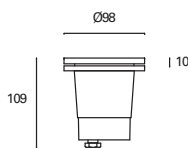

PX-1200-NEG ●

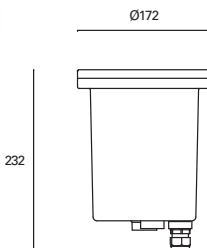

Ideal para instalar en superficies blandas (tierra, césped) que no requieran caja de empotrar. Apto para instalar en primera línea de mar.

Ideal to install on soft surfaces (soil, grass) that do not require embedding box. Suitable for installation close to the sea.

Idéal à installer sur des surfaces molles (sol, de l'herbe) qui ne nécessitent pas la boîte intégration. Convient pour les installations en face de la mer.





## Tamesis

MAT  
Aluminio  
Aluminium  
Aluminium

DIF  
Cristal  
Glass  
Verre

Blanco + Gris + Antracita  
White + Grey + Anthracite  
Blanc + Gris + Anthracite



PX-0047-GRI ○ + ● + ●

E-27  
Max. 60W  
L 145 mm -  
Ø 45 mm

V/Hz  
100-240V  
50-60Hz

Class I

18

IP44

IK08

Included

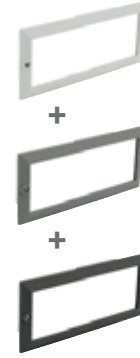
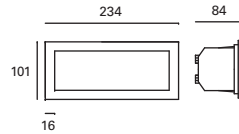

\*  
PX-0047-GRI:  
3 tapas incluidas  
PX-0047-GRI:  
3 covers included  
PX-0047-GRI:  
3 couvertures inclus

MAT  
Aluminio + Acero inoxidable AISI 304  
Aluminium + Stainless steel AISI 304  
Aluminium + Acier inoxydable AISI 304

DIF  
Cristal  
Glass  
Verre

Acero inoxidable  
Stainless steel  
Acier inoxydable



PX-0465-INO ●

E-27  
Max. 60W  
L 145 mm -  
Ø 45 mm

V/Hz  
100-240V  
50-60Hz

Class I

18

IP44

IK08

Included

✓

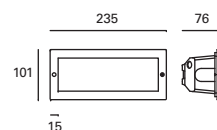

\*

PX-0465-INO:  
Incluye accesorio de rejilla  
para el difusor.

PX-0465-INO:  
Includes grille accessory  
for the diffuser.

PX-0465-INO:  
Comprend un accessoire  
à grille pour le diffuseur.





## Stair

- MAT** Acero inoxidable AISI 304  
Stainless steel AISI 304  
Acier inoxydable AISI 304
- DIF** Policarbonato  
Polycarbonate  
Polycarbonate
- Acero inoxidable  
Stainless steel  
Acier inoxydable



PX-0122-INO ●

\*  
Difusor antideslumbramiento.  
Anti-glare diffuser.  
Le diffuseur empêche l'éblouissement.

**W TOTAL** 1,3W    **LED** 1W    3000°k  
 150 lm    Included 100-240V 50-60Hz

Class II    40    IP54    IK10    0,25 m    Included    ✓

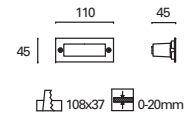

## Face

- MAT** Aluminio Aluminium
- DIF** Cristal Glass Verre
- Gris Grey Gris



PX-0284-GRI ● 3000°k 340 lm  
PX-0285-GRI ● 4000°k 370 lm

**W TOTAL** 3,3W    **LED** 2,5W    Included 100-240V 50-60Hz

Class I    50    IP65    IK10    Included    ✓

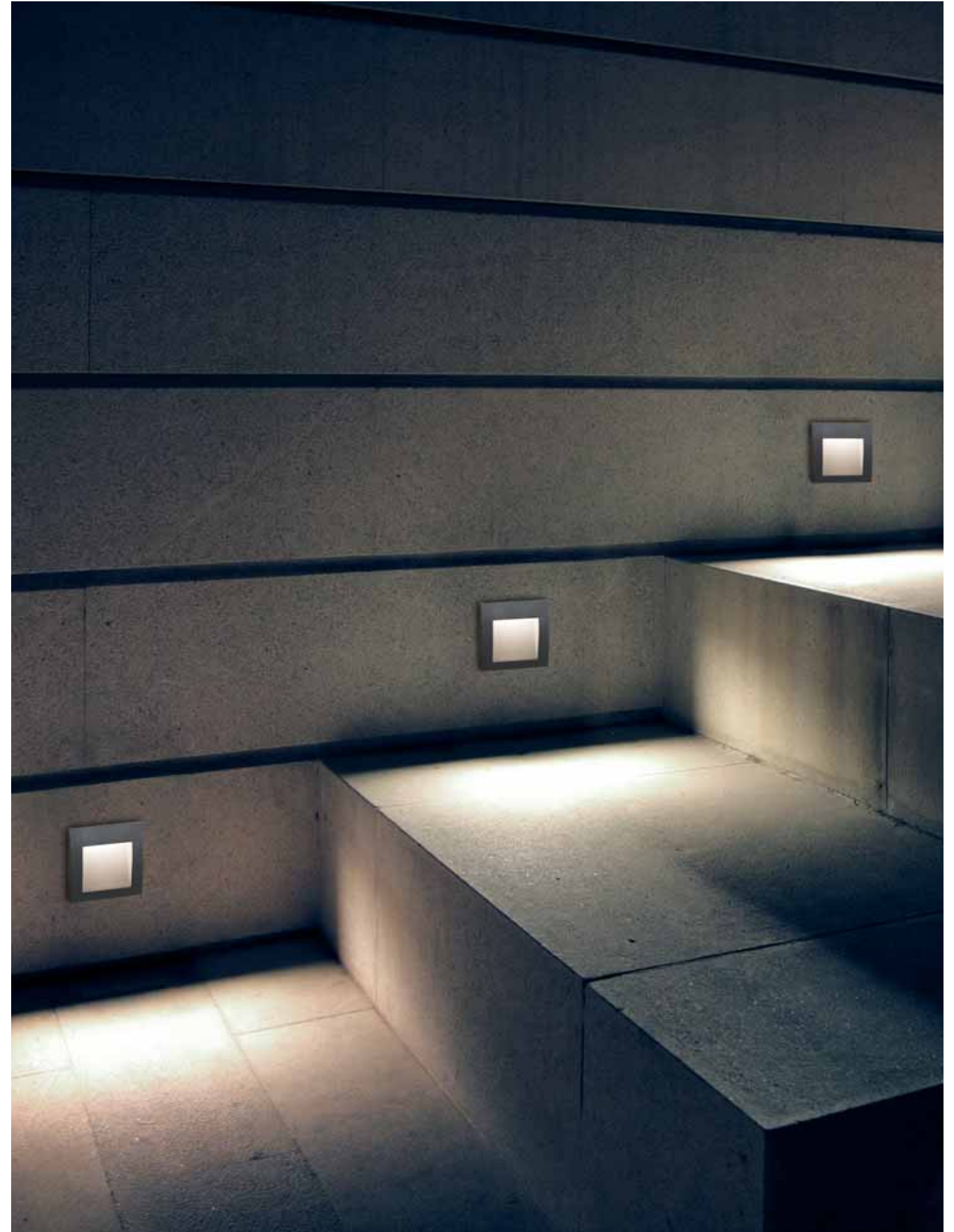
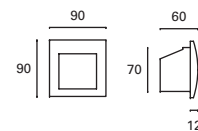



# Picnic

MAT Aluminio Aluminium

DIF Cristal Glass Verre

Negro Black Noir



\* Incluye accesorios para instalar en el pavimento o directamente en el césped.  
It includes accessories to be installed on the pavement or directly on the grass.  
Avec accessoires inclus pour l'installer sur le pavement ou bien directement sur l'herbe.

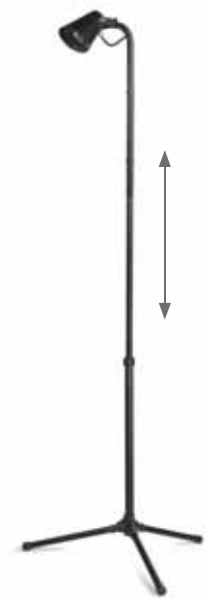
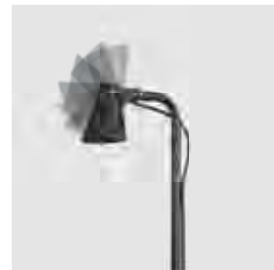

\*  
Altura regulable  
1'10m - 1'50m.  
Adjustable height  
1'10m - 1'50m.  
Réglable en hauteur  
1'10m - 1'50m.

Ⓢ PX-0365-NEG ●

GU10  
 Max. 35W  
 L 60 mm - Ø 55 mm  
 V/Hz  
 100-240V  
 50-60Hz  
 Class I  
 10  
 IP65  
 IK05  
 180°  
 0,2 M  
 4,5 m  
 Included  
 ✓

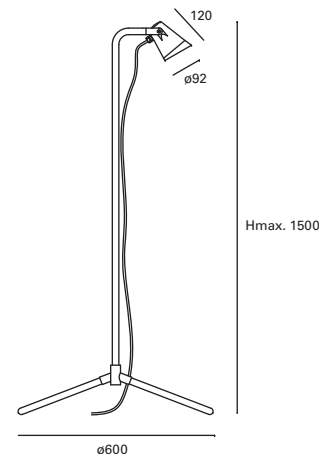



# Post

- MAT Aluminio  
Aluminium  
Aluminium
- DIF Cristal  
Glass  
Verre
- Blanco  
White  
Blanc
- Negro  
Black  
Noir
- Gris  
Grey  
Gris



PX-1400-BLA ○  
PX-1400-GRI ●  
PX-1400-NEG ●

\*  
Resistente al agua a presión.  
High pressure water resistant.  
Résistant à l'eau sous pression.

GU10	100-240V	Class I	20	IP65	IK09	0,5 M	Included	✓
Max. 50W	50-60Hz							
L 55 mm -								
Ø 50 mm								

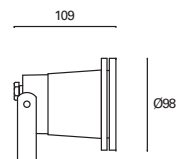



# April

- MAT Aluminio Aluminium Aluminium
- DIF Policarbonat Polycarbonate Polycarbonate
- Gris urbano Urban grey Gris urbain

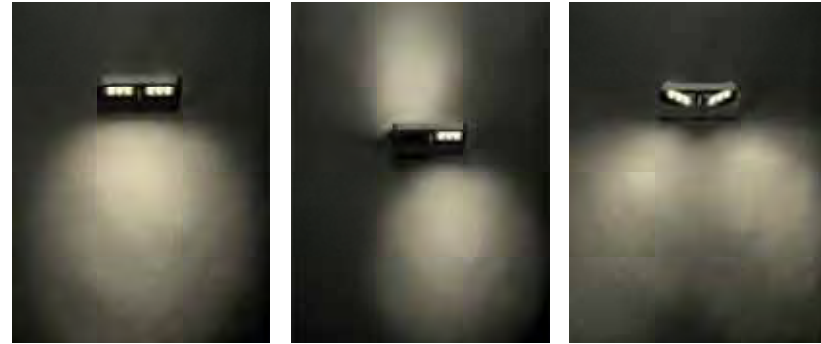

\*  
 Efecto de la luz fácilmente ajustable.  
 Easily adjustable light effect  
 Effet de lumière facilement ajustable.



PX-0470-ANT ●

<b>W</b> TOTAL 13,9W	<b>LED</b> 11W 1135 lm 3000°K	Included 100-240V 50-60Hz	Class I	8	IP54	Sea Side Suitable	IK10	90°	V
----------------------------	--	---------------------------------	---------	---	------	-------------------	------	-----	---

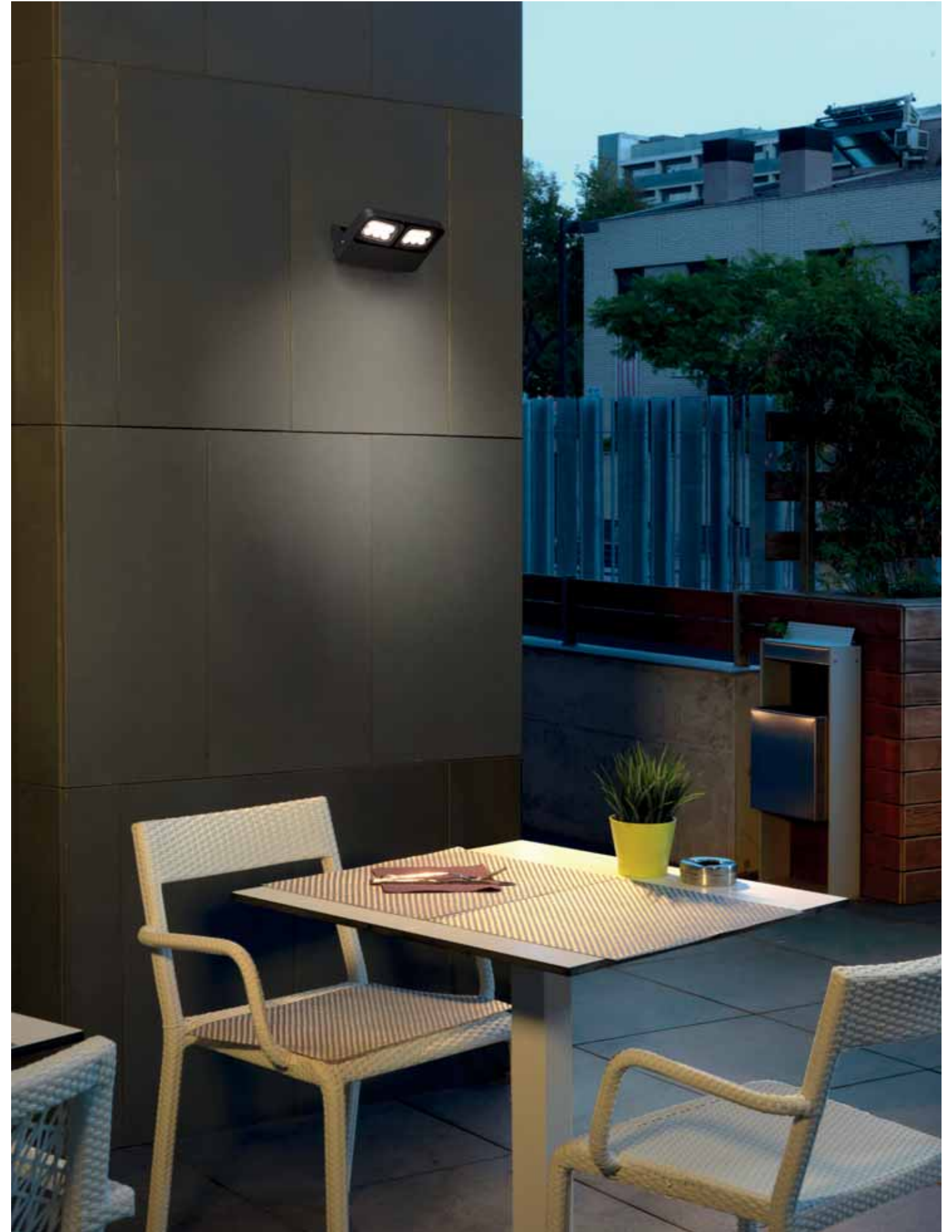
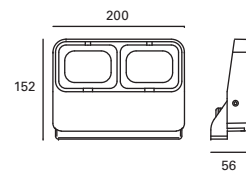



# Neo

MAT Polycarbonato + ABS  
Polycarbonate + ABS  
Polycarbonate + ABS

DIF Polycarbonato  
Polycarbonate  
Polycarbonate

Negro  
Black  
Noir



PX-0374-NEG ●

**W TOTAL** 6W    **LED** 4,5W 500 lm 3000°k  
 Included 100-240V 50-60Hz    Class I    16    IP65    Sea Side Suitable    90°    Included    ✓

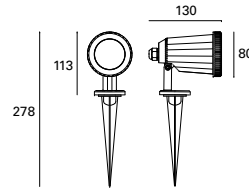

PX-0516-NEG ●

**W TOTAL** 4W    **LED** 4W 410 lm 2700°k / 6000°k (RGB\*)  
 Included 220-240V 50-60Hz    Class II    16    IP65    IK10    Sea Side Suitable    90°    Included    ✓

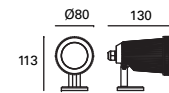

\*WARM&COOL: Permite ajustar la intensidad y la temperatura de color de la luz desde blanco cálido hasta blanco frío. Allows you to adjust the light intensity and colour temperature, from warm white to cool white. Permet de régler l'intensité et la température de couleur de la lumière, du blanc chaud au blanc froid

# Tidian

MAT Polycarbonato + ABS  
Polycarbonate + ABS  
Polycarbonate + ABS

DIF Polycarbonato  
Polycarbonate  
Polycarbonate

Negro  
Black  
Noir



PX-0214-NEG ●

**W TOTAL** GU10 Max. 35W L 58 mm - Ø 60 mm    **V/Hz** 100-240V 50-60Hz    Class II    20    IP65    Sea Side Suitable    IK07    60°    90°    0,2 M    Included    ✓

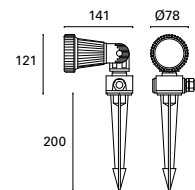

✳  
Resistente al agua a presión. Apto para instalar en primera línea de mar.  
High pressure water resistant. Suitable for installation close to the sea.  
Eau à haute pression résistant. Convient pour les installations en face de la mer.

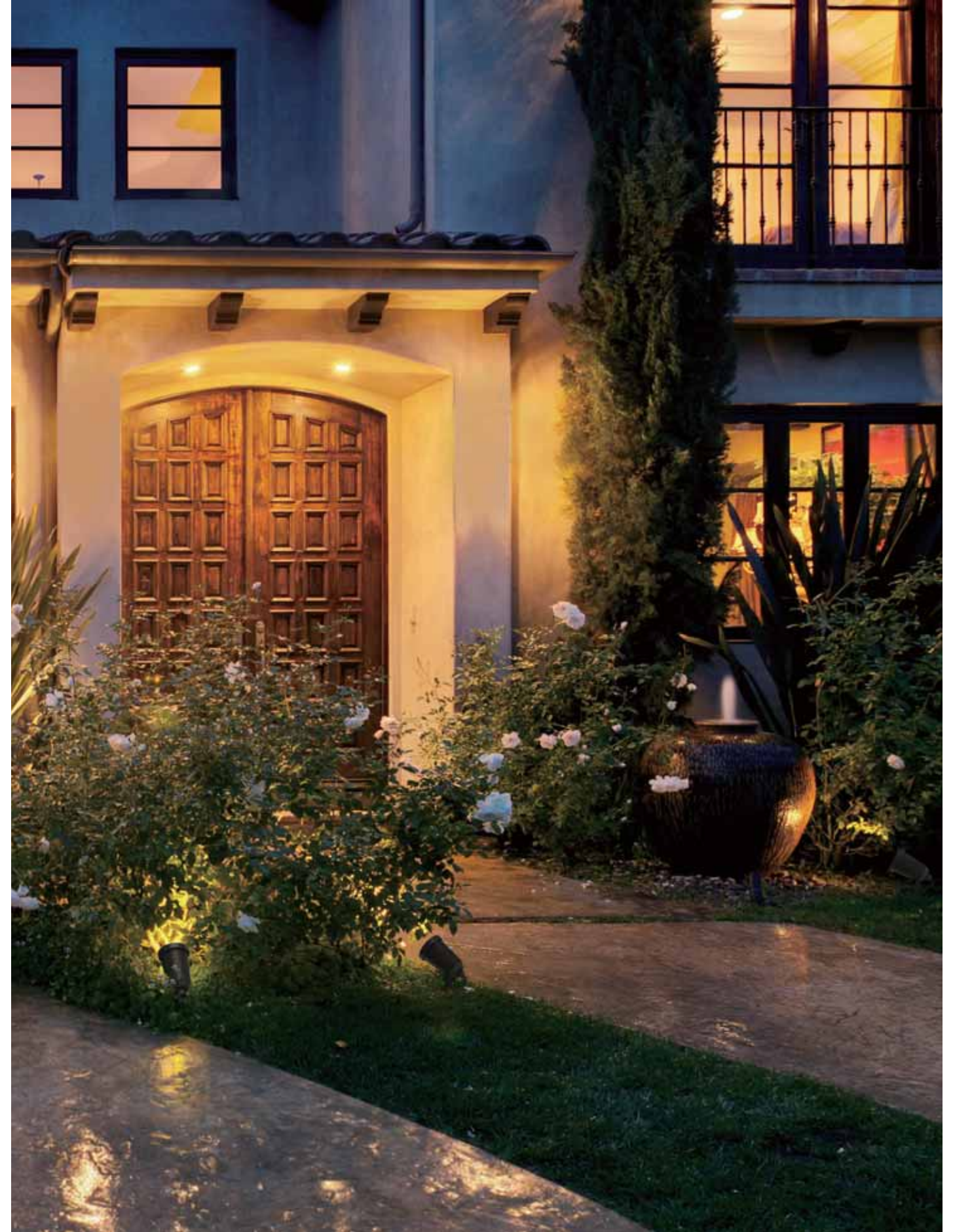





## Minimal Green

MAT Aluminio Aluminium

DIF Cristal Glass Verre

● Negro Black Noir



\* Luz verde ideal para iluminar jardines. Resistente al agua a presión. Ideal for illuminating gardens with green light. High pressure water resistant. Idéal pour éclairer les jardins avec de la lumière verte. Résistant à l'eau sous pression.

PX-0111-NEG ●

**W TOTAL** 7,4W **LED** 6W 420 lm **GREEN** Included 100-240V 50-60Hz Class II 20 IP65 IK08 38° 150° 0,25 m Included ✓

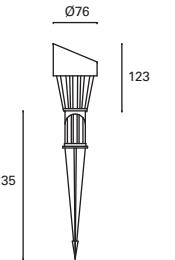

## Minimal

MAT Aluminio Aluminium

DIF Cristal Glass Verre

● Negro Black Noir



\* Incluye 30 cm de cable. It includes cable 30 cm. Il comprend un câble de 30 cm.

PX-0144-NEG ● 3000°K  
PX-0361-NEG ● 4000°K

**W TOTAL** 6,8W **LED** 5,7W 680 lm Included 100-240V 50-60Hz Class I 12 IP65 IK10 68° 180° 0,3 m Included ✓

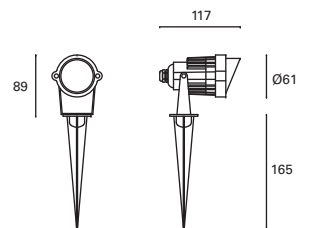



## Propper

MAT Polycarbonato  
Polycarbonate  
Polycarbonate

DIF Polycarbonato  
Polycarbonate  
Polycarbonate

● Gris  
● Grey  
● Gris

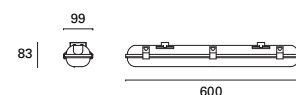

### PX-0145-GRI ●

**W TOTAL** 17,7W  
**LED** 15,6W  
1750 lm  
4000k

Included 100-240V 50-60Hz

Class II 8 IP65 Sea Side Suitable IK10 ✓

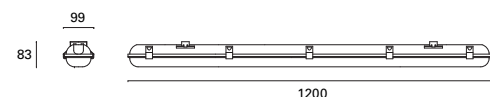
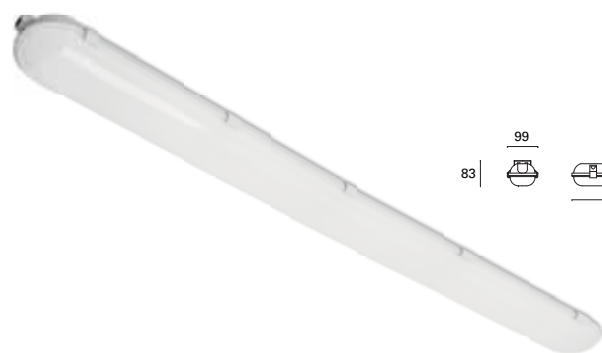

### PX-0221-GRI ●

**W TOTAL** 39W  
**LED** 35,6W  
3550 lm  
4000k

Included 100-240V 50-60Hz

Class II 8 IP65 Sea Side Suitable IK10 ✓

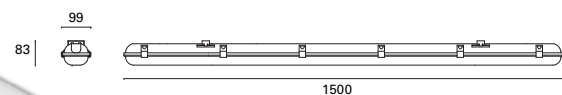

### PX-0222-GRI ●

**W TOTAL** 56,7W  
**LED** 54W  
5500 lm  
4000k

Included 100-240V 50-60Hz

Class II 8 IP65 Sea Side Suitable IK10 ✓



Clips sintéticos para evitar la oxidación + 2 prensa estopas incluidos para facilitar la instalación en serie.

Synthetic clips to prevent rusting + 2 cable grips to facilitate serial installations.

Agrafe plastique anti-rouille + 2 glandes inclus pour faciliter l'installation en série.



Resistente al agua a presión. Apto para instalar en primera línea de mar.

High pressure water resistant. Suitable for installation close to the sea.

Eau à haute pression résistant. Convient pour les installations en face de la mer.



## Selene

MAT  
Aluminio  
Aluminium  
Aluminium

DIF  
Cristal + PMMA  
Glass + PMMA  
Verre + PMMA

● Gris  
Grey  
Gris





PX-0464-GRI ●

 GU10  
 Max. 35W  
 L 52 mm -  
 Ø 50 mm

 V/Hz  
 100-240V  
 50-60Hz

 Class I

 6

 IP54

 0,5 M



\*  
Incluye difusor en color azul.  
Includes diffuser in blue  
Comprend un diffuseur de couleur bleue.

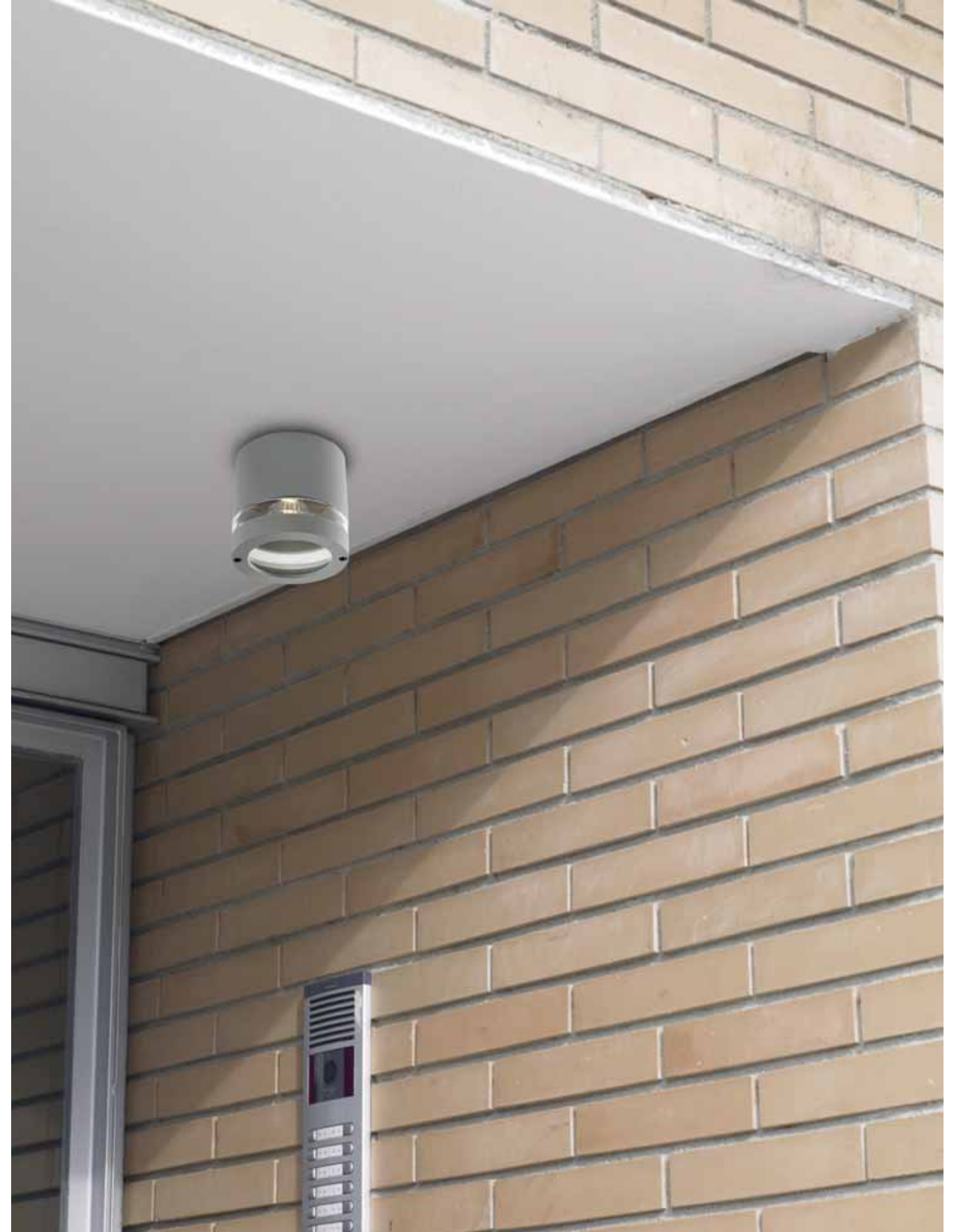
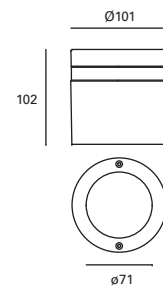



# Ford

MAT Polycarbonato + ABS  
Polycarbonate + ABS  
Polycarbonate + ABS

DIF Polycarbonato  
Polycarbonate  
Polycarbonate

Blanco  
White  
Blanc

Gris  
Grey  
Gris

Negro  
Black  
Noir



Ⓢ PX-0248-GRI ● 4000°k 1224 lm  
Ⓢ PX-0248-NEG ● 4000°k 1224 lm

**W TOTAL** 12,5W    **LED** 11W  
 Included 100-240V 50-60Hz  
 Class II    6    IP65    Sea Side Suitable    IK10

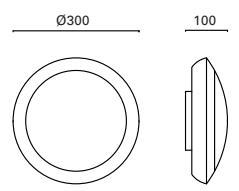

PX-0142-GRI ●  
Ⓢ PX-0142-NEG ●

E27 Max. 11W L 150 mm - Ø 50 mm  
**V/Hz** 100-240V 50-60Hz  
 Class II    12    IP65    Sea Side Suitable    IK10

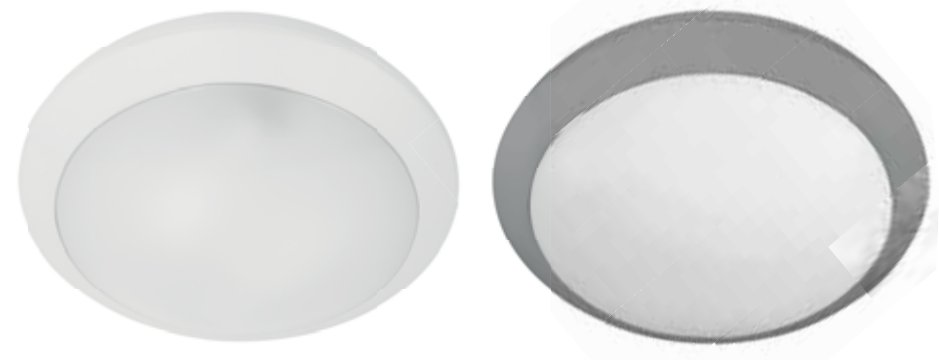
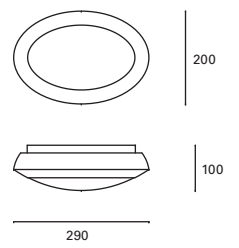

PX-1801-BLA ○  
PX-1801-GRI ●

\*  
Resistente a los impactos IK10.  
Resistente al agua a presión.  
Impact resistant IK10.  
High pressure water resistant.  
Résistant aux impacts IK10.  
Eau à haute pression résistant.

2xE27 2xMax. 20W L 150 mm - Ø 50 mm  
**V/Hz** 100-240V 50-60Hz  
 Class II    6    IP65    Sea Side Suitable    IK10

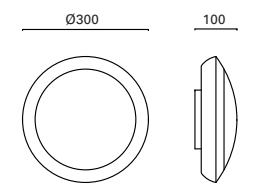



## Rhino

MAT Polycarbonato  
Polycarbonate  
Polycarbonate

DIF Polycarbonato  
Polycarbonate  
Polycarbonate

● Gris urbano  
Urban grey  
Gris urbain



PX-0096-ANT ●

**LED**  
8W  
900 lm  
4000°k

Included  
220-240V  
50-60Hz

Class II 12 IP65

Sea Side Suitable IK10 ✓

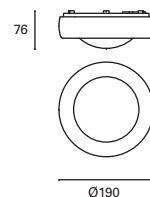

PX-0097-ANT ●

**LED**  
9W  
1050 lm  
4000°k

Included  
220-240V  
50-60Hz

Class II 12 IP65

Sea Side Suitable IK10 ✓

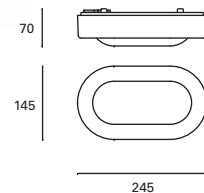

Resistente al agua a presión.  
Apto para instalar en primera  
línea de mar.

High pressure water resistant.  
Suitable for installation close to  
the sea.

Eau à haute pression résistant.  
Convient pour les installations  
en face de la mer.





## Rhiana

MAT

Aluminio  
Aluminium  
Aluminium

DIF

Policarbonato opal  
Opal polycarbonate  
Polycarbonate opale

●

Gris urbano  
Urban grey  
Gris urbain

PX-0110-ANT ●

 E27  
 Max. 18W  
 L 130 mm -  
 Ø 70 mm

 V/Hz  
 100-240V  
 50-60Hz

 Class II

 2

 IP44

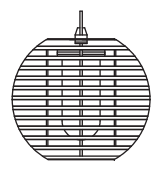

290

254



Regulable en altura hasta 250 cm.  
Apto para uso en pérgolas.

Height adjustable up to 250 cm.  
Suitable for use on pergolas.

Réglable en hauteur jusqu'à 250 cm.  
Convient pour une utilisation sur des pérgolas.

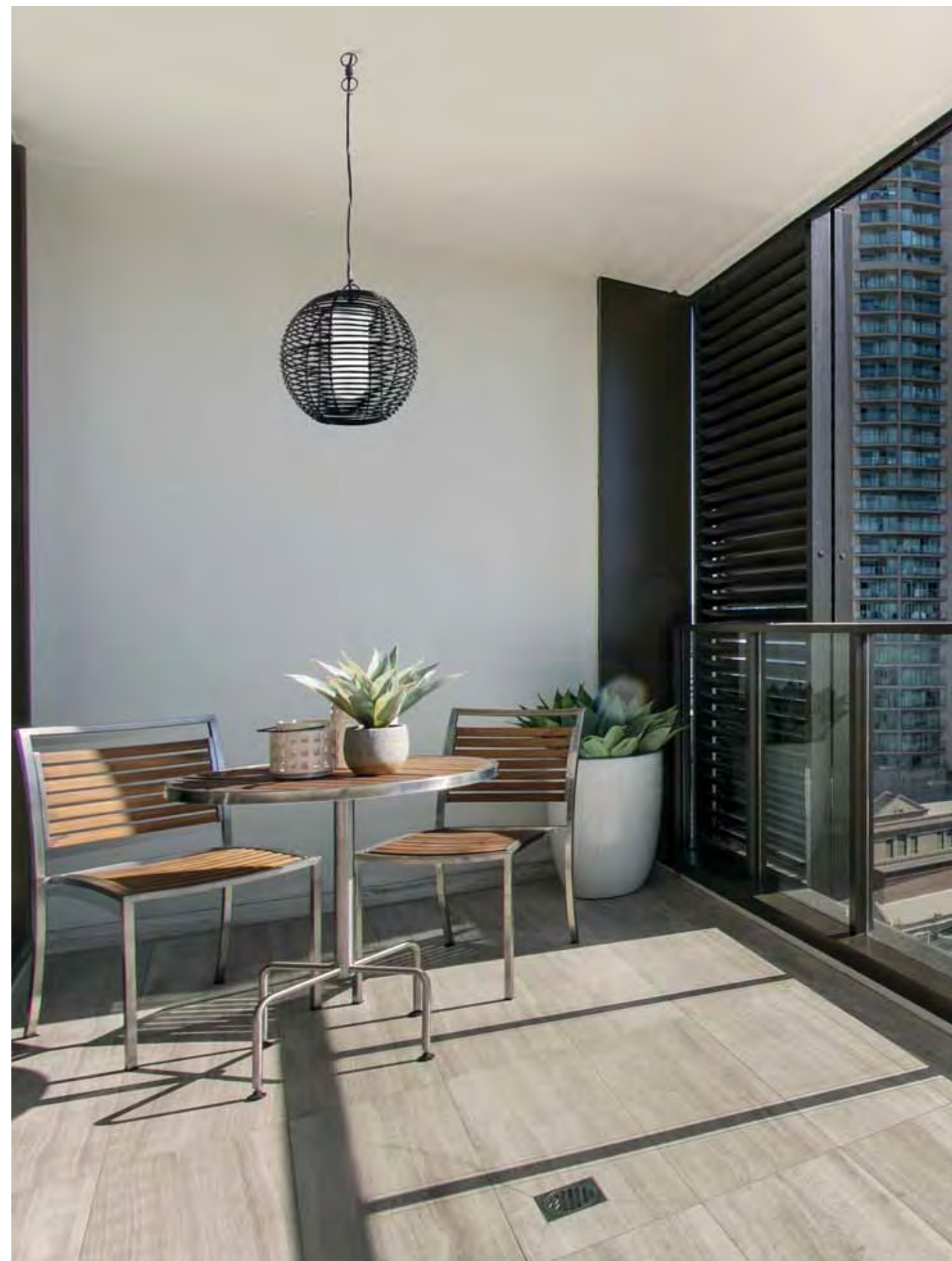



# Pergola

MAT Aluminio Aluminium Aluminium

DIF Policarbonato Polycarbonate Polycarbonate

Blanco White Blanc

Marrón Brown Marron

Gris urbano Urban grey Gris urbain



- Ⓢ PX-0105-BLA ○
- Ⓢ PX-0105-MAR ●
- Ⓢ PX-0105-ANT ●

<b>W</b> TOTAL 8,4W	<b>LED</b> 7,5W 1020 lm 3000°K	Included 220-240V 50-60Hz	Class I	6	IP44	IK08	0,4 m	✓
---------------------------	---	---------------------------------	---------	---	------	------	-------	---

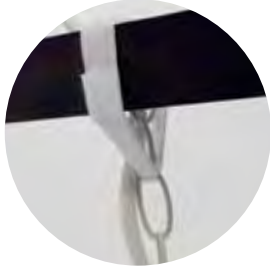
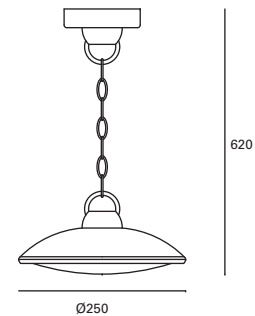

✳  
Apto para uso en pérgolas gracias a los velcro incluidos para la instalación.  
Suitable for use on pergolas thanks to the velcro included for installation.  
Convient pour une utilisation sur des pergolas grâce à la bande velcro inclus pour sa fixation.





# Moon

- MAT ABS  
ABS  
ABS
- DIF Polietileno  
Polyethylene  
Polyéthylène
- Gris  
Grey  
Gris



PX-0478-BLA ○

E27  
 Max. 23W  
 L 180 mm  
 V/Hz  
 100-240V  
 50-60Hz  
 Class II  
 8  
 IP65  
 IK10  
 2,5 m  
 Included

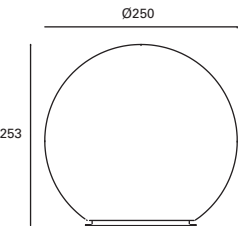

# Sphere

- MAT Policarbonato  
Polycarbonate  
Polycarbonate
- DIF Polietileno  
Polyethylene  
Polyéthylène
- Negro  
Black  
Noir



\*  
 Cable cargador de 1,2 metros incluido. Duración de la batería: 5 horas (100%).  
 1,2 meters charging cable included. Battery duration: 5 hours (100%).  
 Câble de chargeur de 1,2 mètres inclus. Durée de la batterie : 5 heures (100%).

DE-0490-NEG ●

**W TOTAL**  
 1,5W  
**LED**  
 1,5W  
 90 lm  
 Not included Recommended: 5V 1A  
 Class III  
 8  
 IP44  
 IK10  
 1,2 m  
 ✓

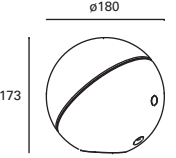

3 intensidades luminicas. 3 brightness settings. 3 intensités lumineuses.

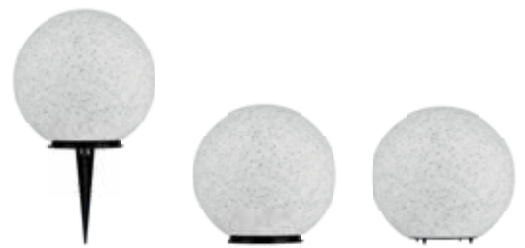

\*  
 Incluye base para fijar sobre muros o superficies duras. Includes base for attaching to tops of walls or hard surfaces. Comprend une base pour fixation sur bornes ou surfaces dures.



# Mush NEW

**MAT** Aluminio  
Aluminium  
Aluminium

**DIF** Policarbonato  
Polycarbonate  
Polycarbonate

**○** Blanco  
White  
Blanc



\*  
Cuero.  
Leather.  
En cuir.



\*  
ON/OFF táctil.  
ON/OFF touch switch.  
ON/OFF tactile.



\*  
Cable USB tipo C  
de 1 metro incluido.  
1 metre USB C-type cable  
included.  
Câble USB type C  
de 1 mètre fourni.

PX-0528-BLA ○

**W TOTAL** 2W  
**LED** 2W 200 lm 3000°k  
Included 5VDC 1000 mA  
Class III 4

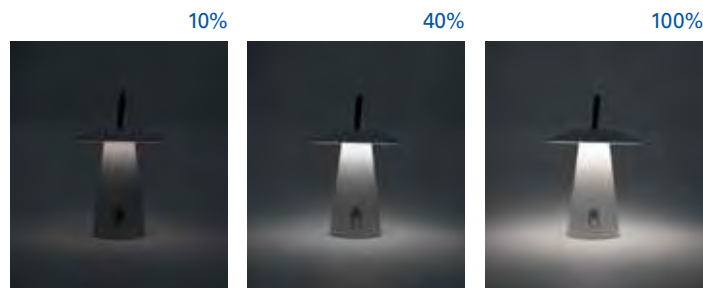
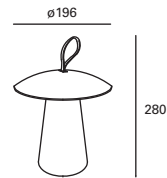

3 intensidades luminicas.  
3 brightness settings.  
3 intensités lumineuses.

\*  
Duración de la batería:  
6,5h 100%, 15h 40% y 80h 10%.  
Battery duration:  
6,5h 100%, 15h 40% and 80h 10%.  
Durée de la batterie:  
6,5h 100%, 15h 40% et 80h 10%.

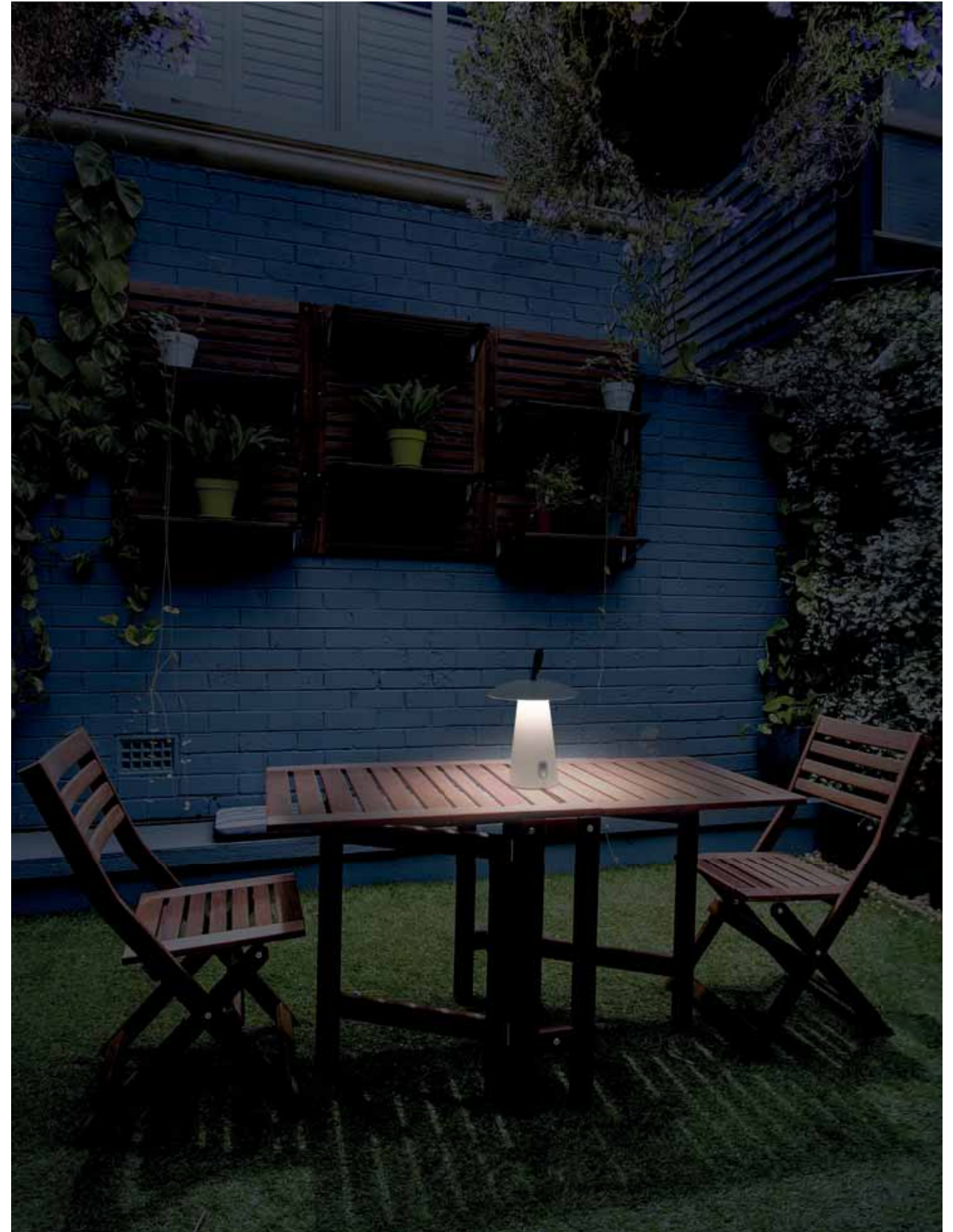



# Magnet NEW

**MAT** Acero / Aluminio  
Stainless / Aluminium  
Acier / Aluminium

**DIF** Policarbonato opal  
Opal polycarbonate  
Polycarbonate opale

**●** Negro  
Black  
Noir



\*  
Cabezal orientable y extraíble gracias a su sistema de fijación magnético.  
Adjustable, removable head thanks to its magnetic fixing system.  
Tête orientable et amovible grâce à son système de fixation magnétique.



\*  
Cable USB tipo C de 1,2 metros incluido.  
1.2 metres USB C-type cable included.  
Câble USB type C de 1,2 mètre fourni.

PX-0529-NEG ●

**W TOTAL** 1,5W  
**LED** 1,5W  
280 lm  
3000°k  
Included 100-240V  
50-60Hz  
Class III  
8

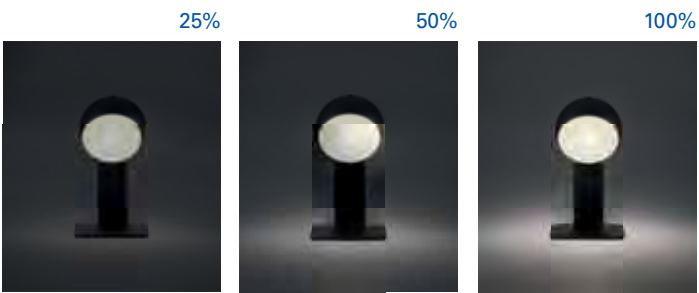
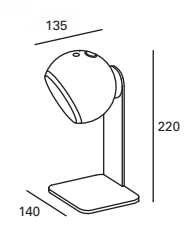

3 intensidades luminicas.  
3 brightness settings.  
3 intensités lumineuses.

\*  
Duración de la batería:  
5h 100%, 10h 50% y 20h 25%.  
Battery duration:  
5h 100%, 10h 50% and 20h 25%.  
Durée de la batterie:  
5h 100%, 10h 50% et 20h 25%.

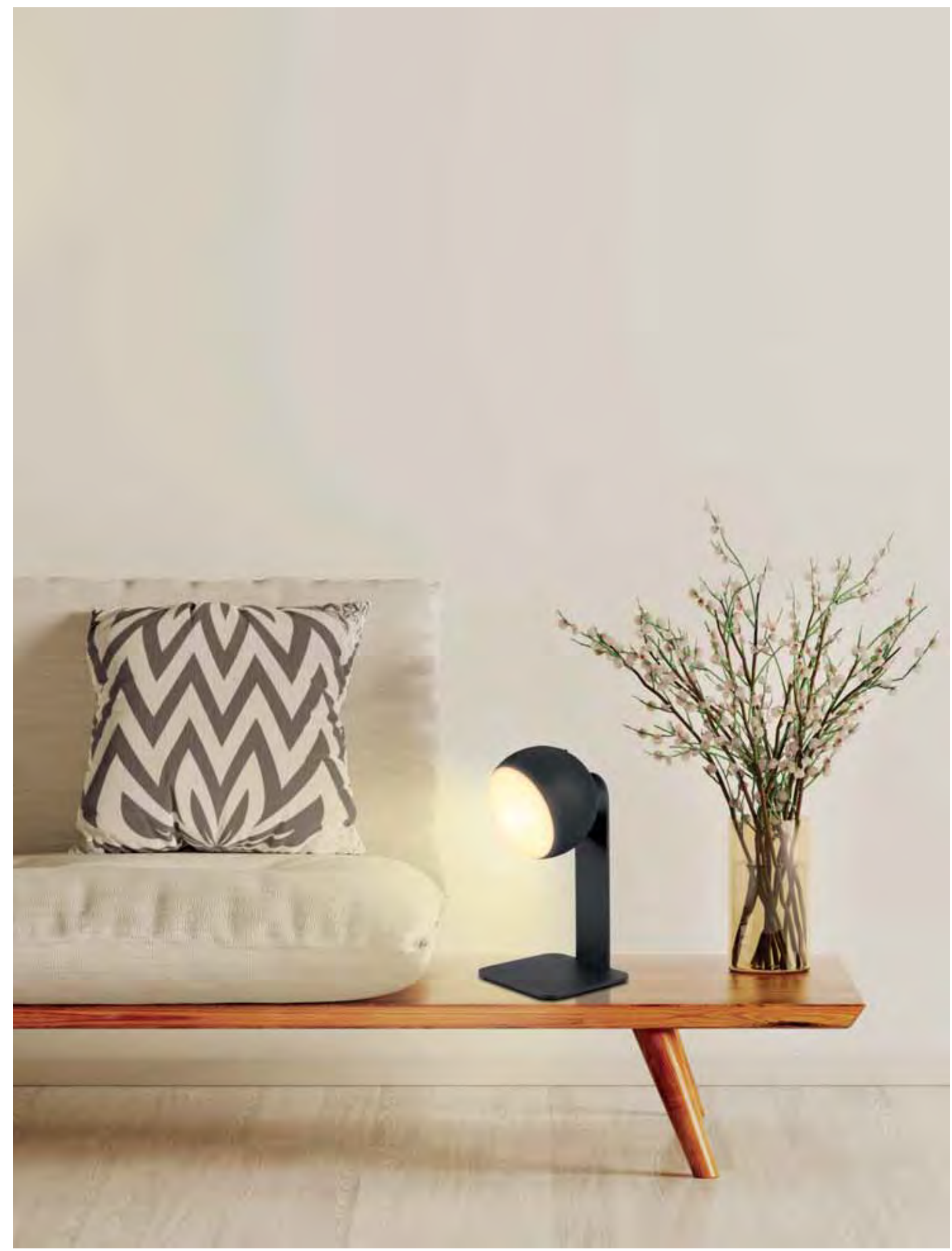

## Night

MAT Aluminio Aluminium Aluminium

DIF Policarbonato Polycarbonate Polycarbonate

Blanco White Blanc



DE-0474-BLA ○

**W TOTAL** 6,5W  
**LED** 1,3W 280 lm 3000°k  
 Included 100-240V 50-60Hz  
 Class II 6 IP54 IK10 ✓

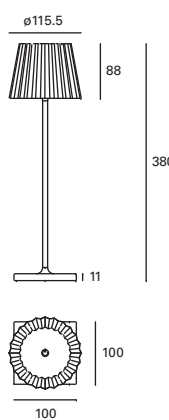

\* Duración de la batería: 9 horas. Cargador incluido.  
 Battery duration: 9 hours. Charger included  
 Durée de la batterie: 9 heures. Chargeur inclus.



\* ON/OFF táctil.  
 ON/OFF touch switch.  
 ON/OFF tactile.





# Ara

MAT Polycarbonato + ABS  
Polycarbonate + ABS  
Polycarbonate + ABS

DIF Polycarbonato  
Polycarbonate  
Polycarbonate

Blanco  
White  
Blanc

Gris urbano  
Urban grey  
Gris urbain



PX-0375-ANT ●  
PX-0375-BLA ○

E27 Max.21W L 90 mm - Ø 45 mm  
V/Hz 100-240V 50-60Hz  
Class II 16 IP65 IK06 Sea Side Suitable

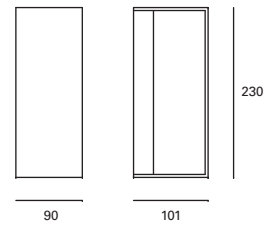

PX-0376-ANT ●  
PX-0376-BLA ○

W TOTAL 9,3W LED 7,2W 820 lm 3000°K  
Included 100-240V 50-60Hz  
Class II 40 IP65 IK06 Sea Side Suitable

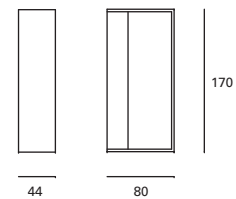



## Kapa

- MAT Aluminio  
Aluminium  
Aluminium
- DIF Policarbonato opal  
Opal polycarbonate  
Polycarbonate opale
- Blanco  
White  
Blanc
- Gris urbano  
Urban grey  
Gris urbain

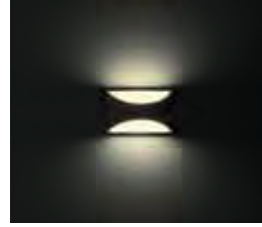

PX-0468-BLA 3000°k  
 N PX-0525-BLA 4000°k

<b>W</b> TOTAL 10,3W	<b>LED</b> 8,7W 945 lm <span style="border: 1px solid black; border-radius: 50%; padding: 2px;">3000°k</span>	Included 220-240V 50-60Hz	Class I	12	IP54	IK10	
----------------------------	--	---------------------------------	---------	----	------	------	--

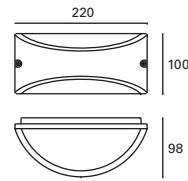

**\***  
 Módulo LED fácilmente  
 reemplazable.  
 Easily replaceable LED module.  
 Module LED facilement  
 remplaçable.



PX-0468-ANT 3000°k  
 N PX-0525-ANT 4000°k

<b>W</b> TOTAL 10,3W	<b>LED</b> 8,7W 945 lm <span style="border: 1px solid black; border-radius: 50%; padding: 2px;">3000°k</span>	Included 220-240V 50-60Hz	Class I	12	IP54	IK10	
----------------------------	--	---------------------------------	---------	----	------	------	--

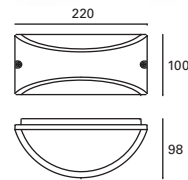



**Mocca** NEW

MAT Aluminium Aluminium

DIF PC opal Opal PC PC opale

Blanco White Blanc

Gris Grey Gris

Negro Black Noir



PX-0493-BLA ○  
 PX-0493-GRI ●  
 PX-0493-NEG ●

**W TOTAL** 4,9W  
**LED** 4,7W 490 lm  
 3000°K  
 Included  
**V/Hz** 220-240V 50-60Hz  
 Class II  
 24  
 IP65 IK08

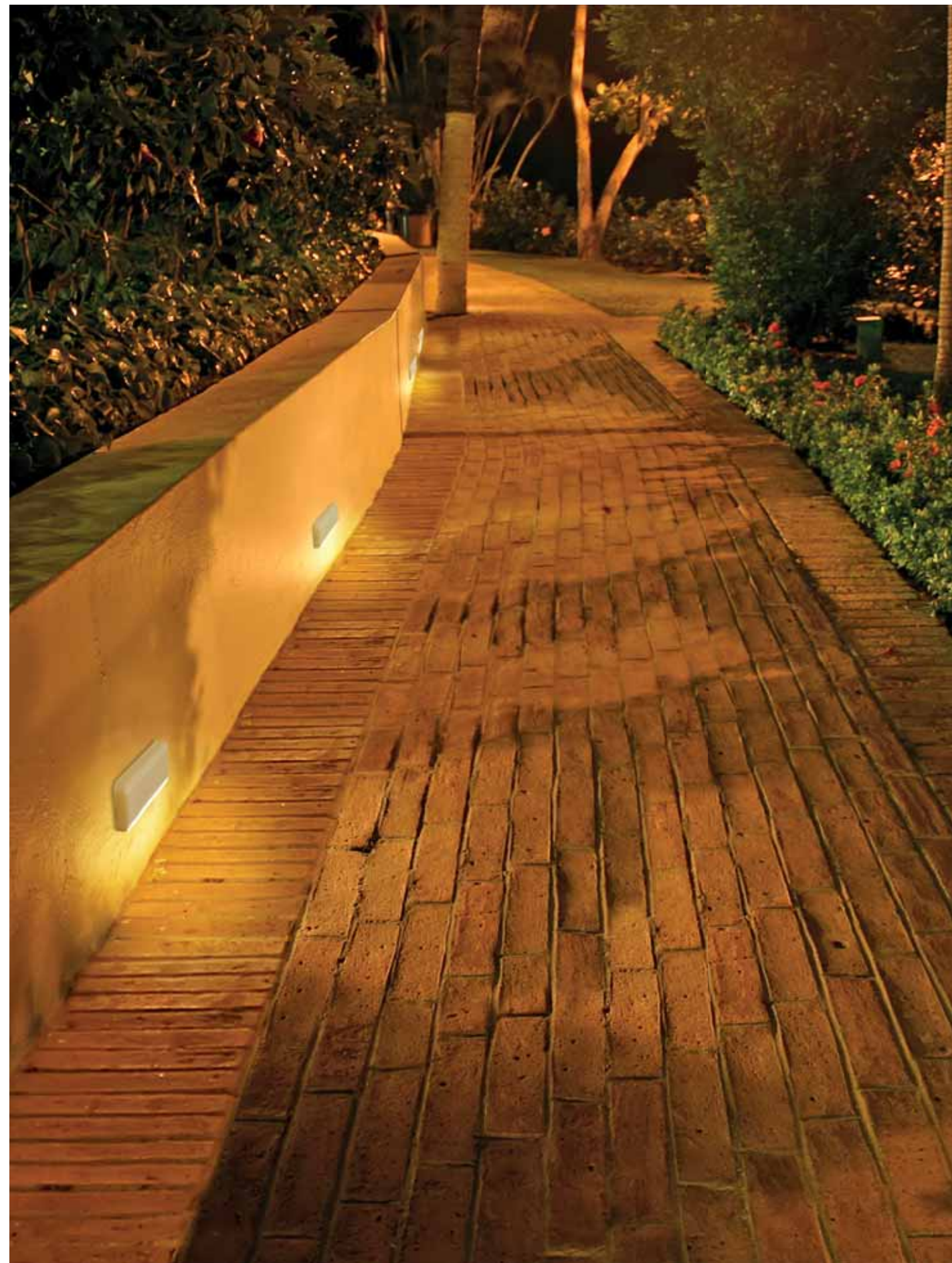
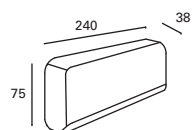



**Box** NEW

MAT Cemento Cement Ciment

DIF Cristal Glass Verre

Cemento Cement Ciment



PX-0527-CEM ●

<b>W</b> TOTAL 4W	<b>LED</b> 4W 380 lm 4000°k	Phase cut	Included 220-240V 50-60Hz	Class II	2	IP65	IK10	
-------------------------	--------------------------------------	-----------	---------------------------------	----------	---	------	------	--

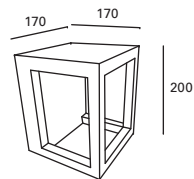

\*  
Acabado 100% cemento.  
100% cement finish.  
Finition 100 % ciment.

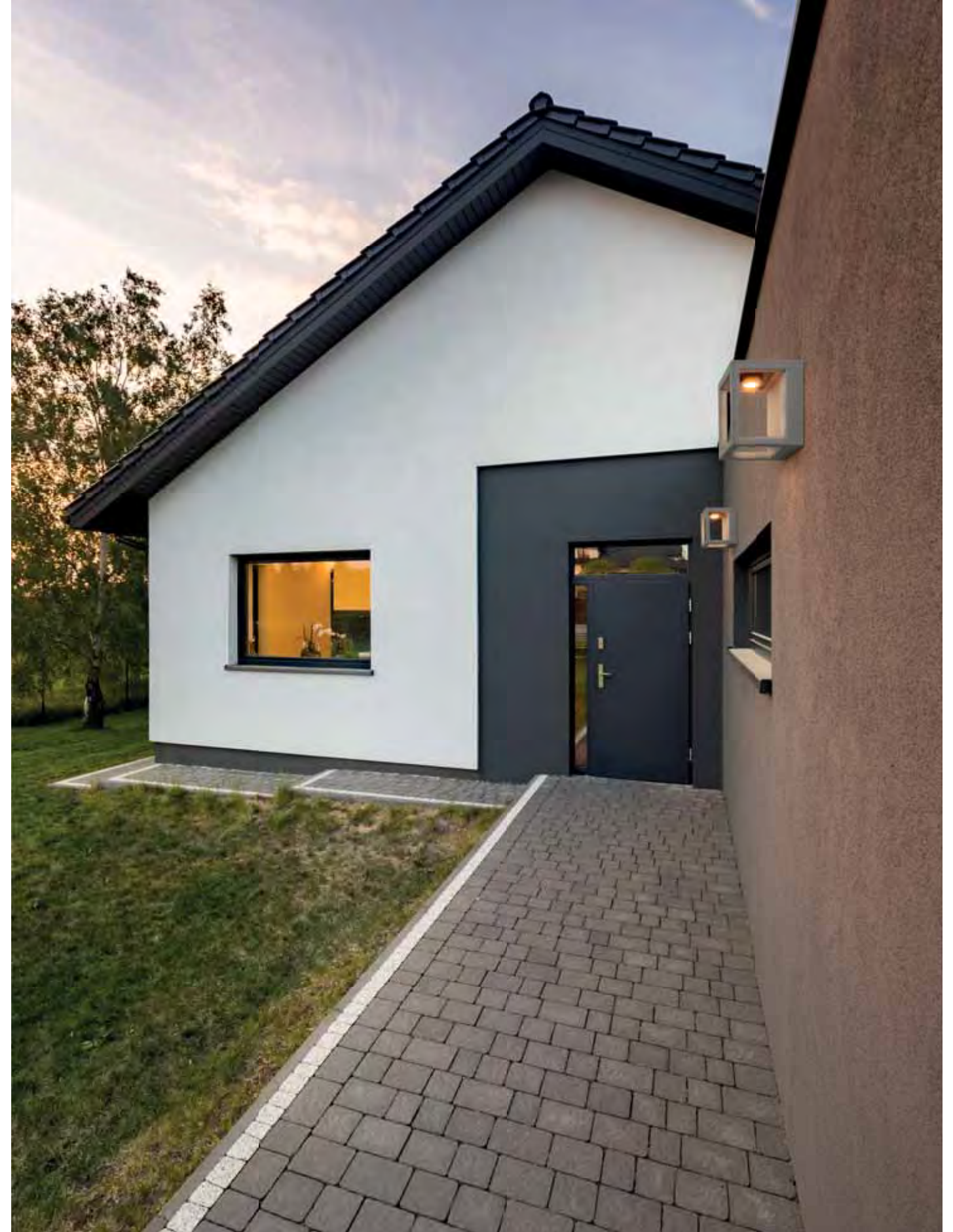



# Wilow

MAT Aluminio Aluminium Aluminium

DIF Cristal Glass Verre

Gris Grey Gris

Negro Black Noir



PX-0397-GRI ●

W TOTAL 8,8W | LED 6,9W 600 lm 3000°K | Included 100-240V 50-60Hz | Class I | 20 | IP54 | IK10 | ✓

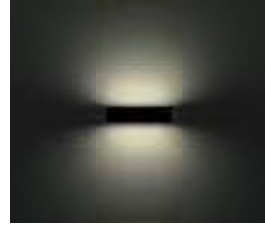
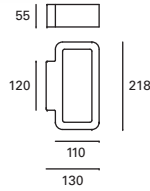

PX-0397-NEG ●

W TOTAL 8,8W | LED 6,9W 600 lm 3000°K | Included 100-240V 50-60Hz | Class I | 20 | IP54 | IK10 | ✓

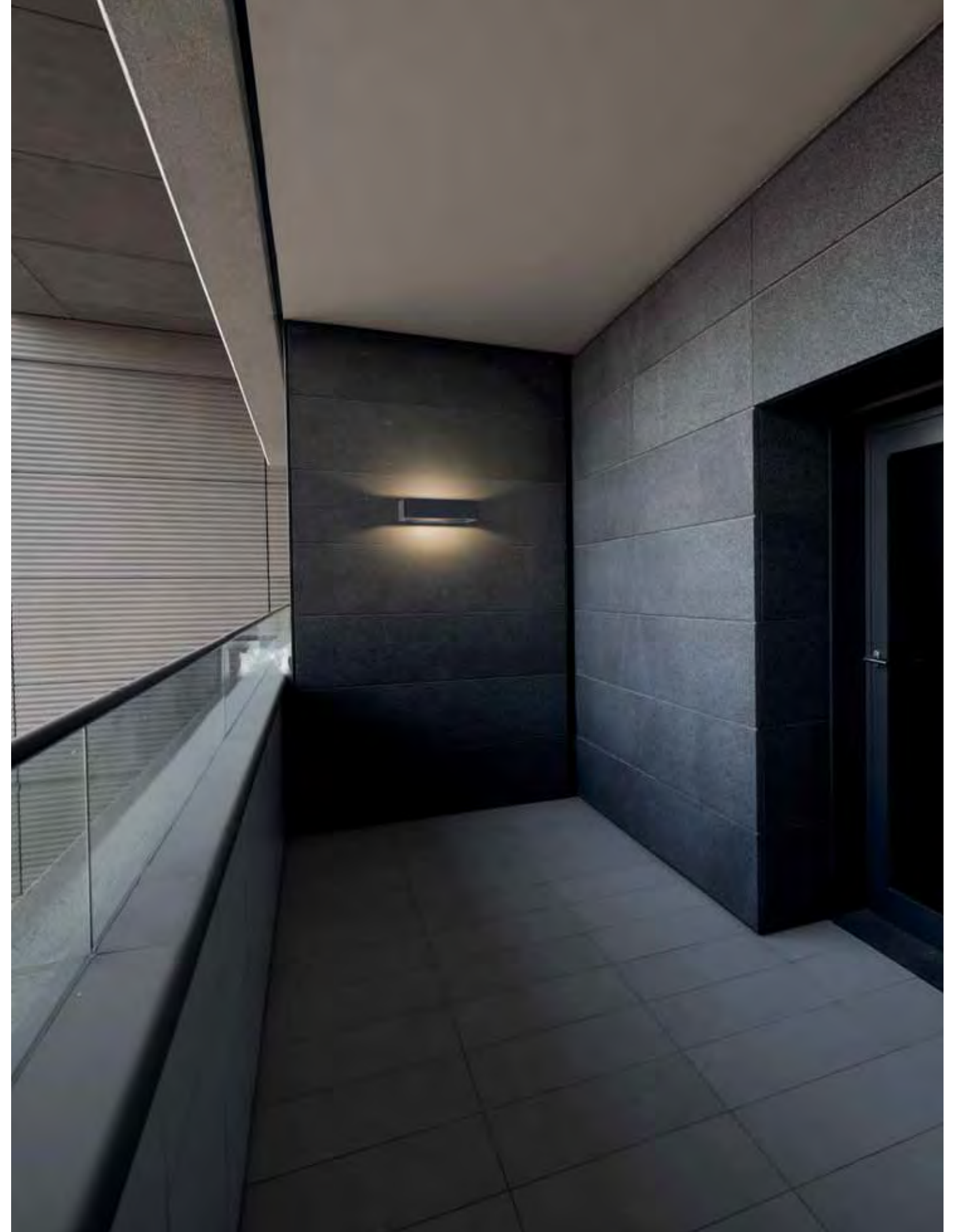
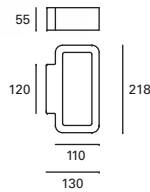

# Rex

MAT Aluminio Aluminium Aluminium

DIF Cristal Glass Verre

Blanco White Blanc

Gris urbano Urban grey Gris urbain



PX-0432-BLA ○ 3000°k  
 N PX-0526-BLA ○ 4000°k

W TOTAL 6,6W LED 5,2W 575 lm  
 Included 100-240V 50-60Hz  
 Class I 27 IP54 IK08 ✓

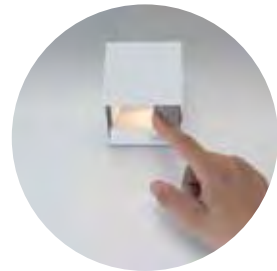
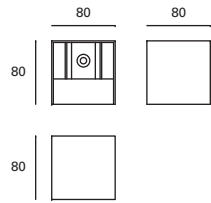
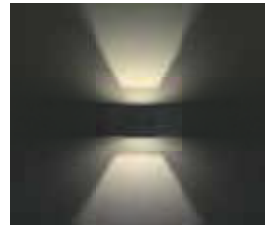
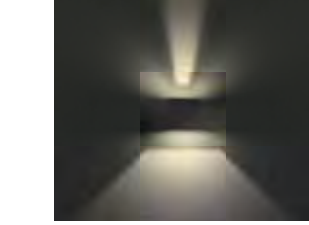

PX-0432-ANT ● 3000°k  
 N PX-0526-ANT ● 4000°k

W TOTAL 6,6W LED 5,2W 575 lm  
 Included 100-240V 50-60Hz  
 Class I 27 IP54 IK08 ✓

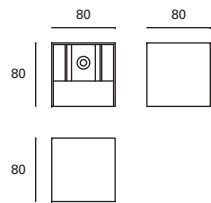

\* Efecto de la luz fácilmente ajustable.  
 Easily adjustable light effect.  
 Effet de lumière facilement ajustable.





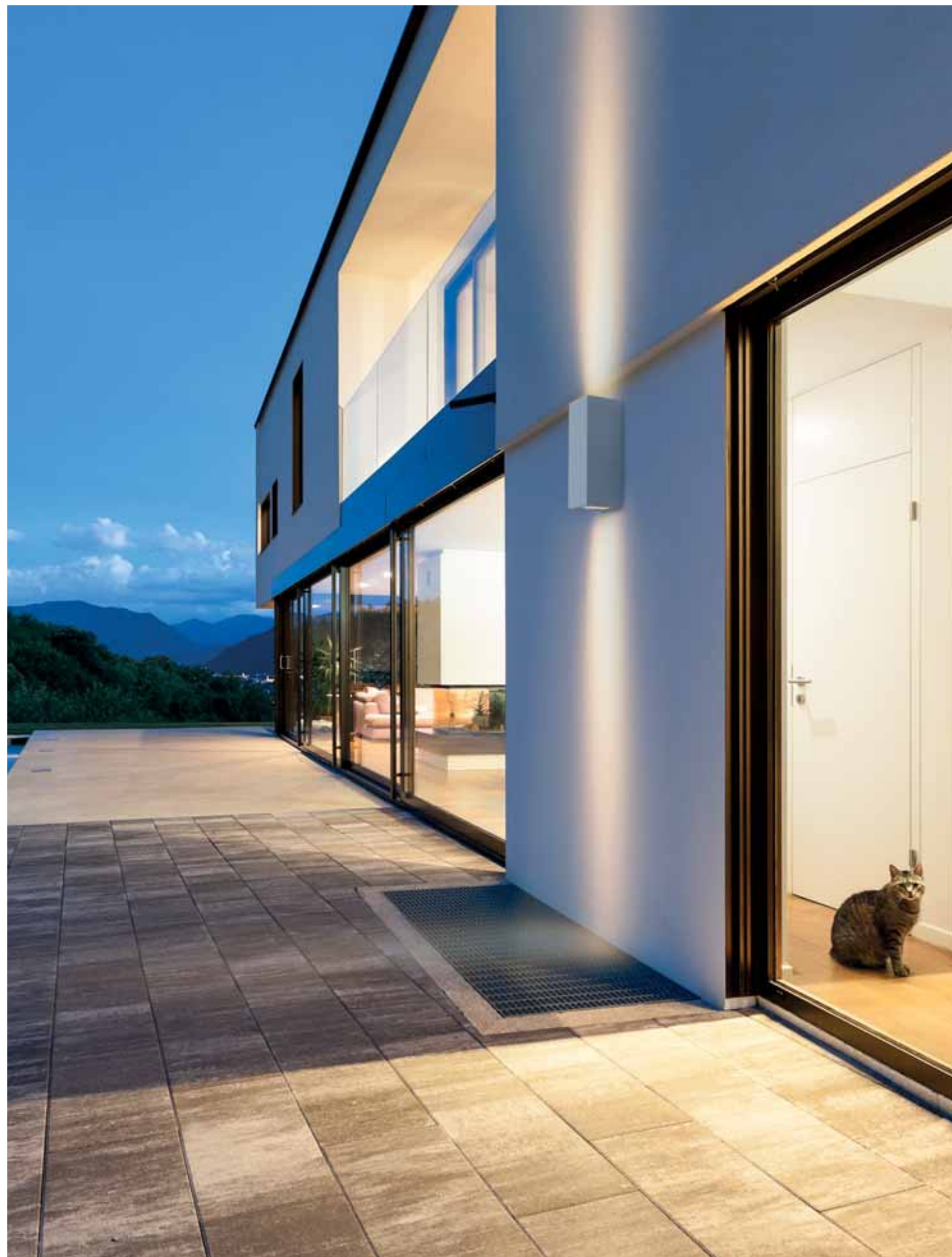

## Cube

MAT Acero  
Steel  
Acier

DIF Cristal  
Glass  
Verre

● Gris  
Grey  
Gris

● Negro  
Black  
Noir

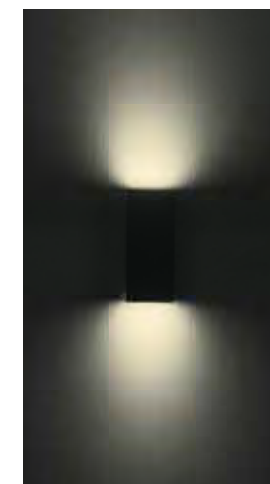

PX-0127-GRI ●  
PX-0127-NEG ●

2xE-27 Par 30  
2xMax.75W  
L 110 mm -  
Ø 96 mm

V/Hz 100-240V  
50-60Hz

Class I

8

IP44

IK04

0.5 M

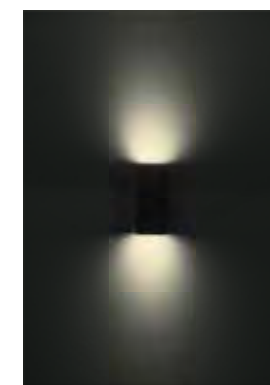
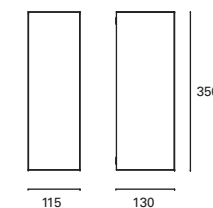

PX-0056-GRI ●  
PX-0056-NEG ●

GU10  
2xMax.35W  
L 70 mm

V/Hz 100-240V  
50-60Hz

Class I

12

IP44

IK03

0.5 M

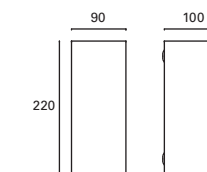



# Slim

MAT Aluminio Aluminium Aluminium

DIF Cristal Glass Verre

Blanco White Blanc

Gris urbano Urban grey Gris urbain



PX-0433-BLA ○

W TOTAL 5W | LED 3,9W 320 lm 3000°K | Included 100-240V 50-60Hz | Class I | 20 | IP54 | V



\* Diseño ultra fino, especialmente pensado para balcones o pasillos.  
Ultra thin design, especially recommended for balconies or corridors.  
Design ultrafin, spécialement conçu pour les balcons ou couloirs.

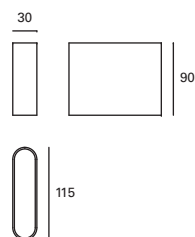

PX-0433-ANT ●

W TOTAL 5W | LED 3,9W 320 lm 3000°K | Included 100-240V 50-60Hz | Class I | 20 | IP54 | V

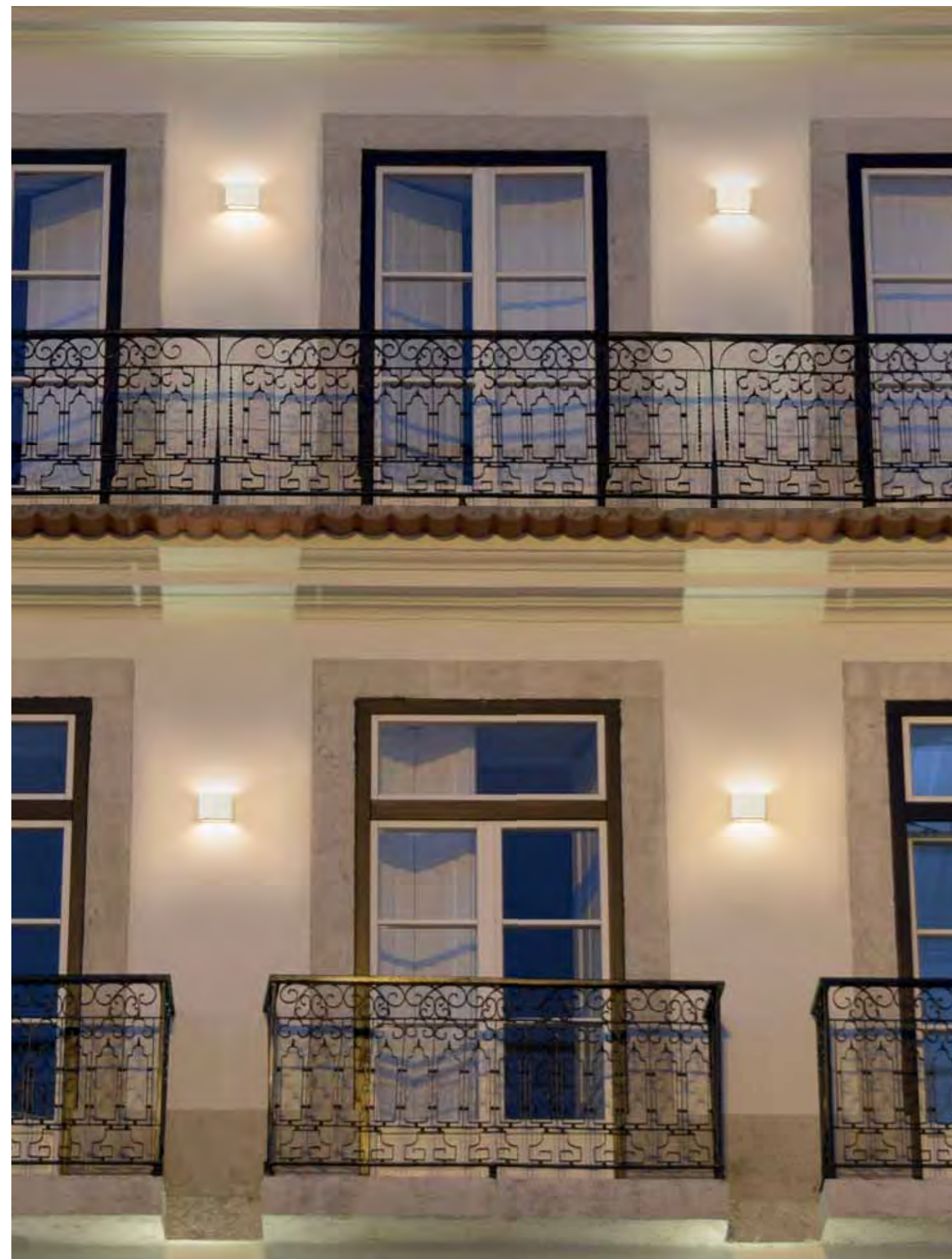
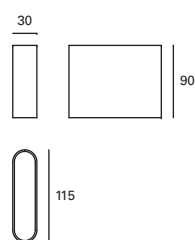



# Loyd

MAT Aluminio Aluminium Aluminium

DIF Cristal Glass Verre

● Gris Grey Gris

● Negro Black Noir

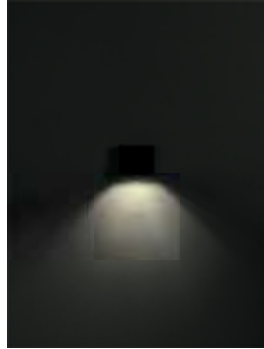

PX-0395-GRI ●  
PX-0395-NEG ●

**W TOTAL** 3,4W  
**LED** 2,1W  
180 lm  
3000°K  
Included 100-240V 50-60Hz  
Class I 20 IP54 ✓

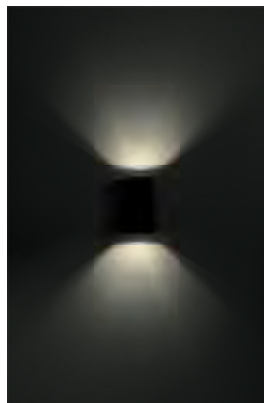
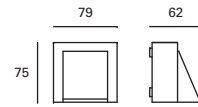

PX-0396-GRI ●  
PX-0396-NEG ●

**W TOTAL** 5,9W  
**LED** 4,1W  
360 lm  
3000°K  
Included 100-240V 50-60Hz  
Class I 20 IP54 ✓

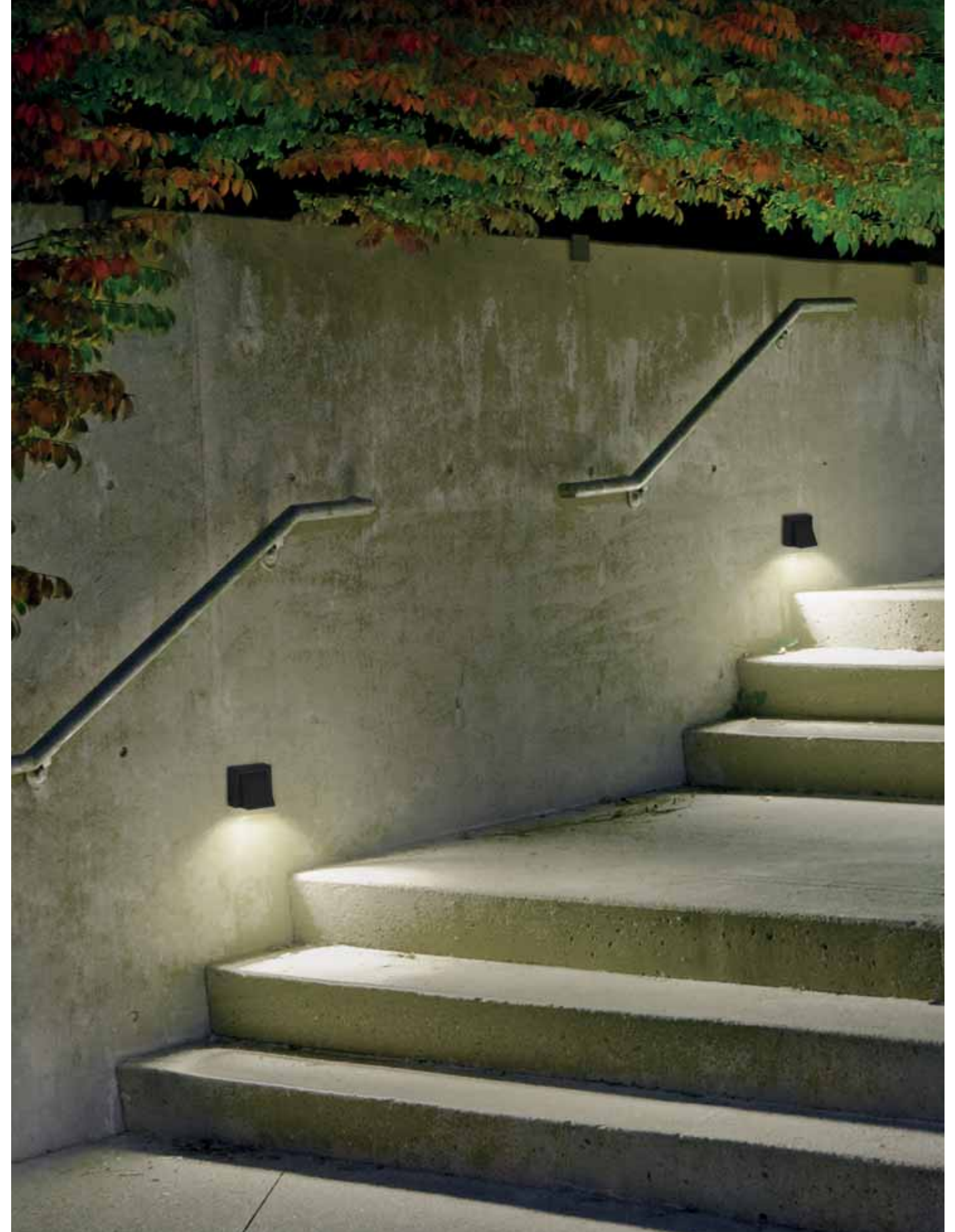
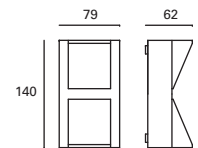



# Karen

- MAT Acero Steel Acier
- DIF Cristal Glass Verre
- Blanco White Blanc
- Gris Grey Gris
- Negro Black Noir



- PX-1900-BLA ○
- PX-1900-GRI ●
- PX-1900-NEG ●

GU10  
 Max. 35W  
 L 55 mm - Ø 50 mm

**V/Hz**  
 100-240V  
 50-60Hz

Class I

20

IP44

IK03

0,2 M

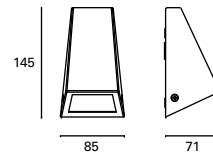

- PX-1901-BLA ○
- PX-1901-GRI ●
- PX-1901-NEG ●

E-27  
 Max. 60W  
 L 120 mm - Ø 60 mm

**V/Hz**  
 100-240V  
 50-60Hz

Class I

10

IP44

IK03

0,5 M

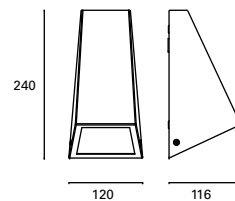

\*  
 Para iluminar sólo hacia abajo.  
 To light only downward.  
 Pour allumer seulement à la baisse.

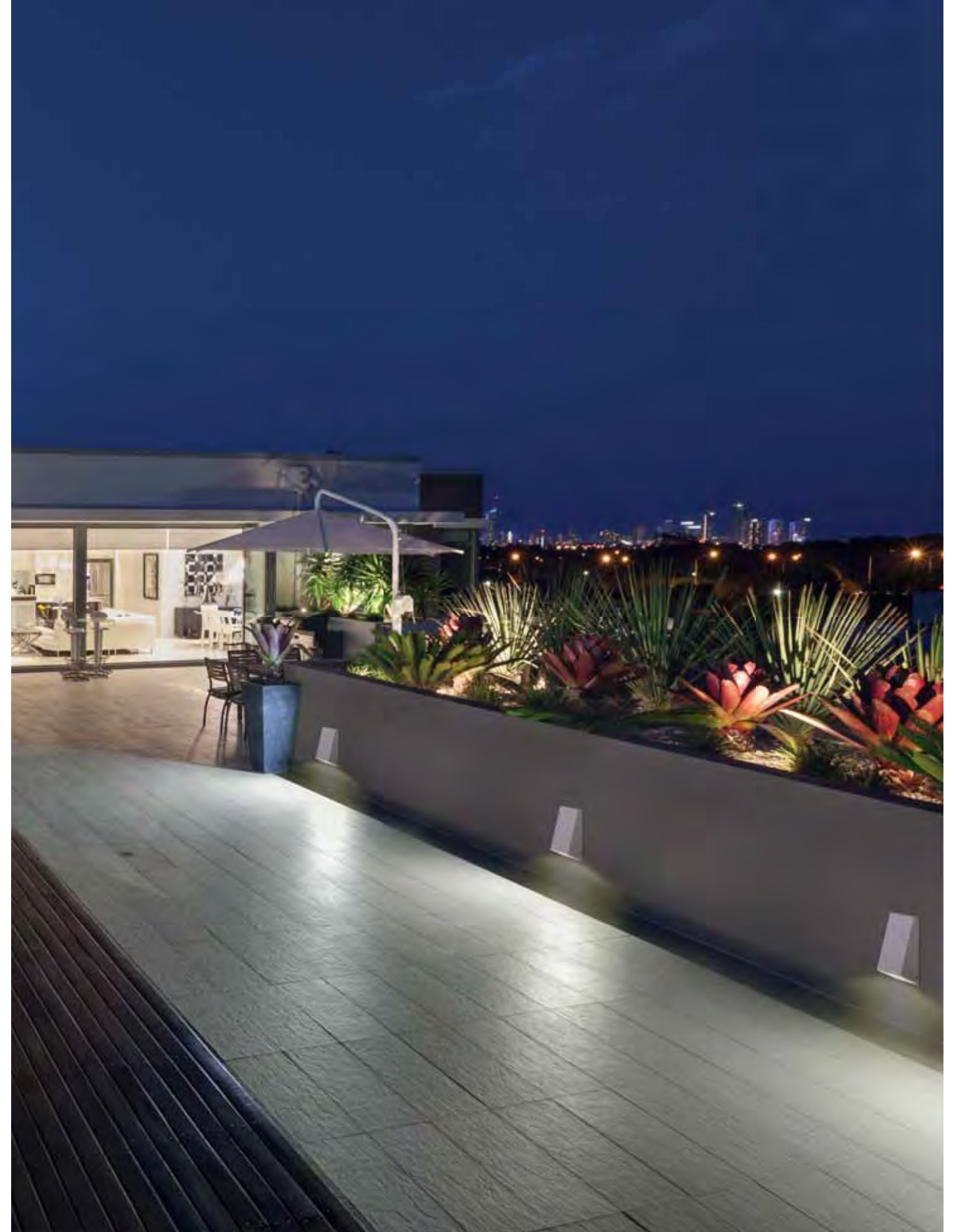



# Orion

MAT Aluminio  
Aluminium  
Aluminium

DIF Cristal  
Glass  
Verre

Gris  
Grey  
Gris

Negro  
Black  
Noir



PX-0378-GRI ●  
PX-0378-NEG ●

**W** TOTAL 7,3W  
**LED** 5,6W  
610 lm  
3000°k  
Included 100-240V  
50-60Hz  
Class I 10 IP54 IK07 ✓

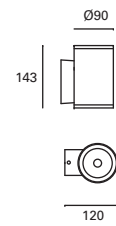

PX-0379-GRI ●  
PX-0379-NEG ●

**W** TOTAL 13,1W  
**LED** 11,3W  
1220 lm  
3000°k  
Included 100-240V  
50-60Hz  
Class I 10 IP54 ✓

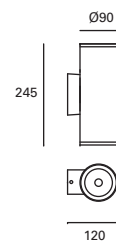

PX-0380-GRI ●  
PX-0380-NEG ●

**W** TOTAL 7,3W  
**LED** 5,6W  
610 lm  
3000°k  
Included 100-240V  
50-60Hz  
Class I 20 IP54 ✓

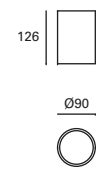

# Mayor

MAT Aluminio Aluminium Aluminium

DIF Cristal Glass Verre

Gris Grey Gris

Gris urbano Urban grey Gris urbain



PX-0005-GRI ●

E-27  
 Max. 60W  
 L 117 mm -  
 Ø 45 mm  
 V/Hz 100-240V 50-60Hz  
 Class I  
 12  
 IP44  
 ✓

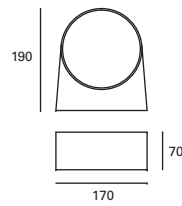

PX-0005-ANT ●

E-27  
 Max. 60W  
 L 117 mm -  
 Ø 45 mm  
 V/Hz 100-240V 50-60Hz  
 Class I  
 12  
 IP44  
 ✓

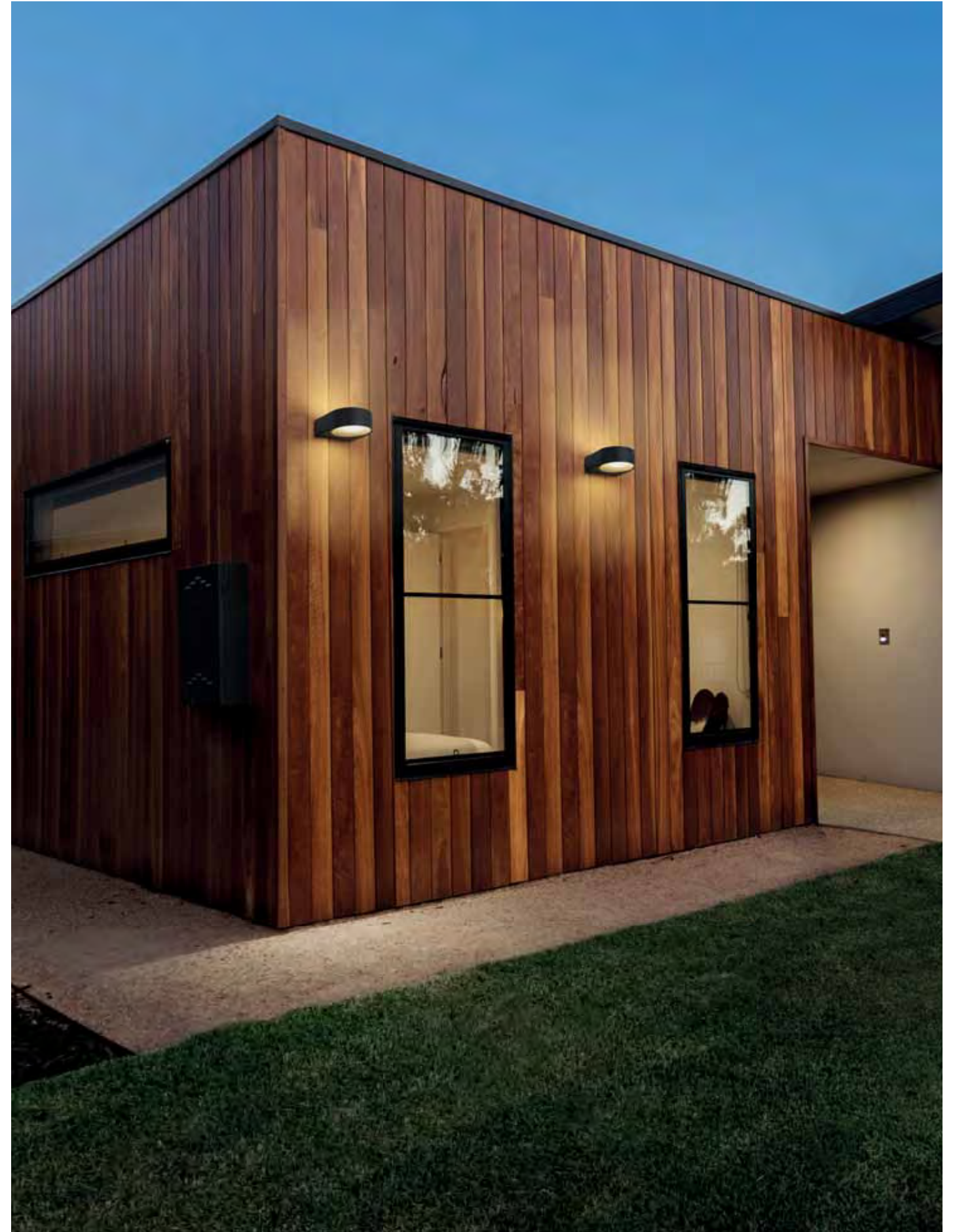
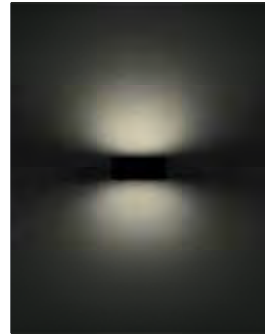
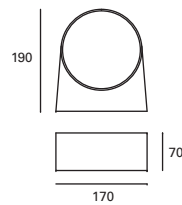



# Jumbo

MAT Polipropileno Polypropylene Polypropylène

DIF Tecnopolímero Technopolymer Technopolymère

● Negro Black Noir

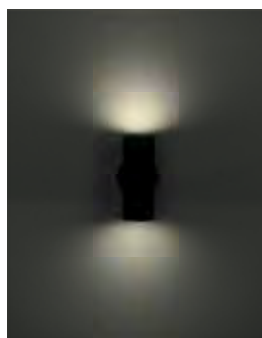

PX-0124-NEG ●

<b>W TOTAL</b> 3,2W	<b>LED</b> 2,4W 280 lm 3000°k	Included 100-240V 50-60Hz	Class II	20	IP54	Sea Side Suitable	IK08	95°	
------------------------	--	---------------------------------	----------	----	------	-------------------	------	-----	--

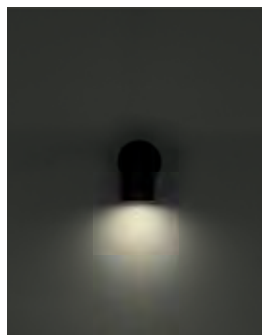
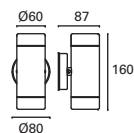

Ⓢ PX-0125-NEG ●

<b>W TOTAL</b> 2,4W	<b>LED</b> 1,8W 160 lm 3000°k	Included 100-240V 50-60Hz	Class II	16	IP54	Sea Side Suitable	IK08	95°	
------------------------	--	---------------------------------	----------	----	------	-------------------	------	-----	--

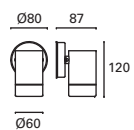

\*  
Apto para instalar en primera línea de mar.  
Suitable for installation close to the sea.  
Convient pour les installations en face de la mer.

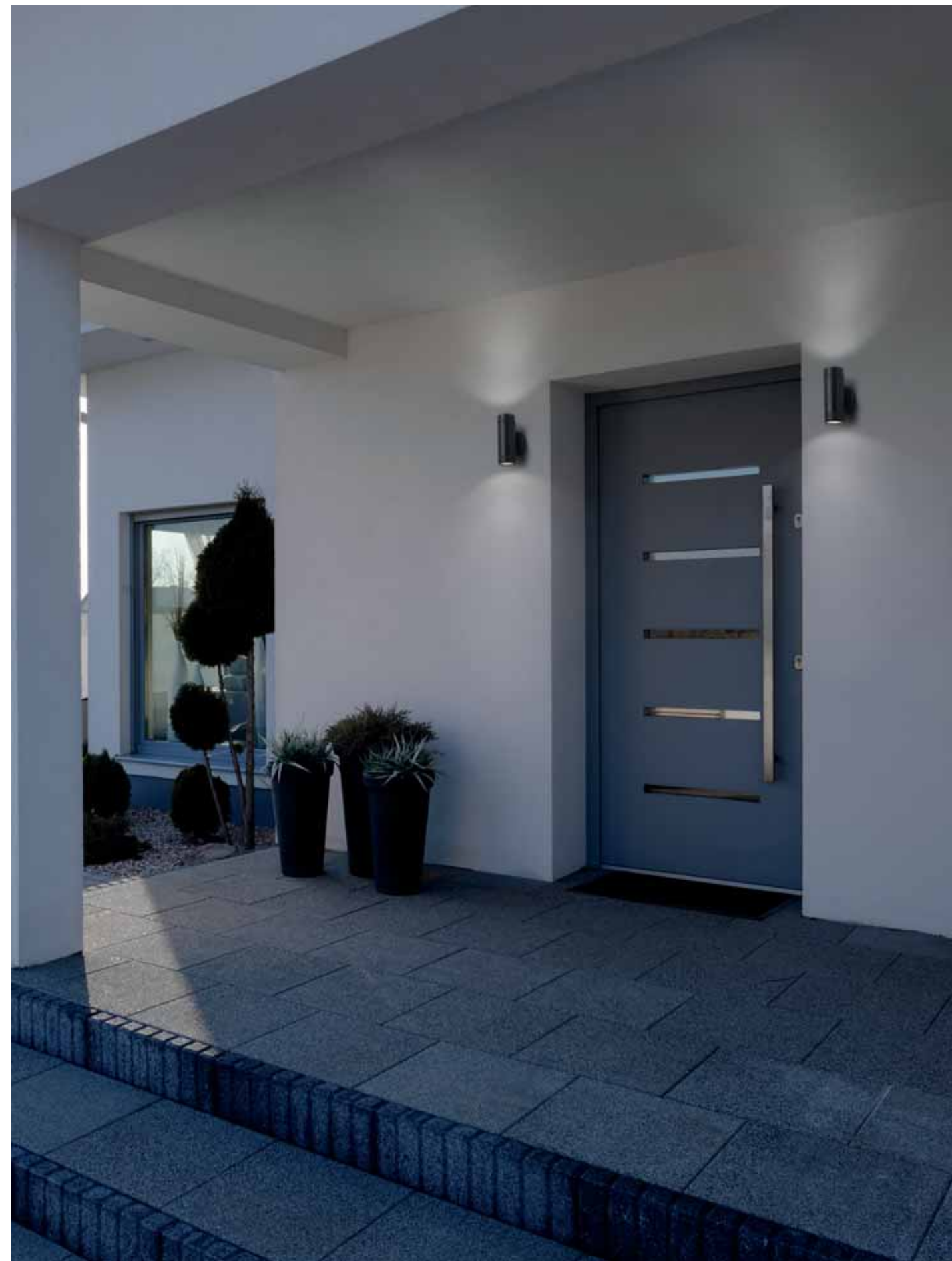



## Serenate

- MAT Aluminio Aluminium Aluminium
- DIF Policarbonato Polycarbonate Polycarbonate
- Negro Black Noir



PX-0254-NEG ●

<b>W TOTAL</b> 8,5W	<b>LED</b> 7,6W 1000 lm 3000°k	Included 100-240V 50-60Hz	Class I	10	IP44	IK10	
------------------------	---	---------------------------------	---------	----	------	------	--

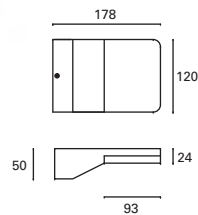

## Samper

- MAT Policarbonato + ABS Polycarbonate + ABS Polycarbonate + ABS
- DIF Policarbonato Polycarbonate Polycarbonate
- Gris Grey Gris
- Negro Black Noir



PX-0353-GRI ●  
PX-0353-NEG ●

**\***  
Resistente al agua a presión.  
Apto para instalar en primera línea de mar.  
High pressure water resistant.  
Suitable for installation close to the sea.  
Eau à haute pression résistant.  
Convient pour les installations en face de la mer.

<b>W TOTAL</b> 12W	<b>LED</b> 10,5W 1100 lm 3000°k	Included 100-240V 50-60Hz	Class II	16	IP65	Sea Side Suitable	IK08	
-----------------------	--	---------------------------------	----------	----	------	-------------------	------	--

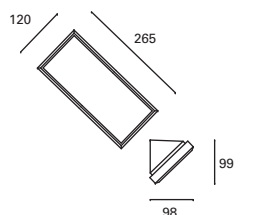





## Noa

- MAT Aluminio Aluminium Aluminium
- DIF Policarbonato Polycarbonate Polycarbonate
- Blanco White Blanc
- Gris Grey Gris



○ **PX-0276-BLA** ○  
● **PX-0276-GRI** ●

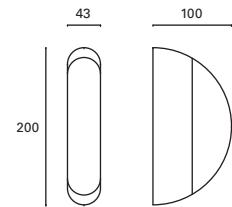

**W TOTAL** 6,3W  
**LED** 5W 480 lm 3000°k  
 Included 100-240V 50-60Hz  
 Class I 12 IP44 IK09

## Area

- MAT Policarbonato + ABS Polycarbonate + ABS Polycarbonate + ABS
- DIF Policarbonato Polycarbonate Polycarbonate
- Blanco White Blanc
- Gris Grey Gris
- Negro Black Noir



○ **PX-0352-BLA**  
● **PX-0352-GRI**  
● **PX-0352-NEG**

\*  
 Resistente al agua a presión. Apto para instalar en primera línea de mar.  
 High pressure water resistant. Suitable for installation close to the sea.  
 Eau à haute pression résistant. Convient pour les installations en face de la mer.

E-27 Max.23W L 150 mm - Ø 55 mm  
 V/Hz 100-240V 50-60Hz  
 Class II 9 IP65 Sea Side Suitable IK09

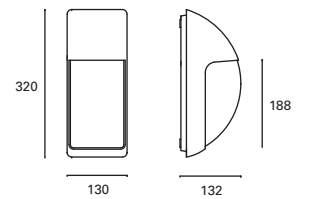



## Dual NEW

MAT Polycarbonato + ABS  
Polycarbonate + ABS  
Polycarbonate + ABS

DIF Polycarbonato mate  
Polycarbonate matt  
Polycarbonate mat

● Gris urbano  
Urban grey  
Gris urbain



PX-0514-ANT ●

**W TOTAL** 4W  
**LED** 4W  
 410 lm  
 2700°k  
 6000°k  
 \* RGB

Included 220-240V  
 50-60Hz

Class II 12 IP65 IK10

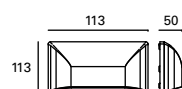

\* **WARM&COOL:** Permite ajustar la intensidad y la temperatura de color de la luz desde blanco cálido hasta blanco frío. Allows you to adjust the light intensity and colour temperature, from warm white to cool white. Permet de régler l'intensité et la température de couleur de la lumière, du blanc chaud au blanc froid

## Grove

MAT ABS  
ABS  
ABS

DIF Polycarbonato  
Polycarbonate  
Polycarbonate

● Negro Black Noir + ○ Blanco White Blanc + ● Gris Grey Gris



PX-0439-NEG ○ + ● + ●

\*  
 Incluye filtro para recrear luz cálida 3000°K.  
 It includes filter to recreate warm light 3000°K.  
 Comprend filtre à recréer une lumière chaude 3000°K.

**W TOTAL** 3,1W  
**LED** 2,6W  
 300 lm  
 4000°k

Included 100-240V  
 50-60Hz

Class II 20 IP65 IK10

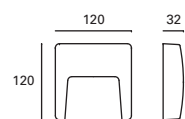

\*  
 3 tapas incluidas.  
 3 covers included.  
 3 couvertures inclus.





# Grove

MAT Polycarbonato + ABS  
Polycarbonate + ABS  
Polycarbonate + ABS

DIF Polycarbonato  
Polycarbonate  
Polycarbonate

Blanco White Blanc + Gris Grey Gris + Negro Black Noir



PX-0126-NEG ○ + ● + ●

**W TOTAL** 1,6W  
**LED** 1,4W  
 200 lm  
 4000°k  
 Included 100-240V  
 50-60Hz  
 Class II  
 40  
 IP65  
 Sea Side Suitable  
 IK10

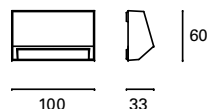

PX-0130-NEG ○ + ● + ●

**W TOTAL** 2,9W  
**LED** 2,5W  
 350 lm  
 4000°k  
 Included 100-240V  
 50-60Hz  
 Class II  
 20  
 IP65  
 Sea Side Suitable  
 IK10

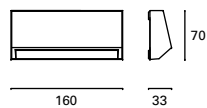

PX-0095-GRI ○ + ● + ●

**W TOTAL** 3,7W  
**LED** 3,1W  
 340 lm  
 4000°k  
 Included 100-240V  
 50-60Hz  
 Class II  
 24  
 IP65  
 Sea Side Suitable  
 IK10

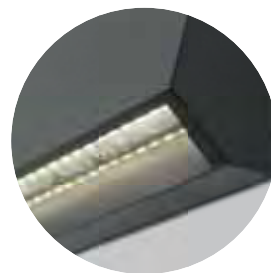
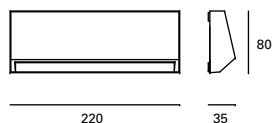

\*  
 Incluye filtro para recrear luz cálida 3000°K.  
 It includes filter to recreate warm light 3000°K.  
 Comprend filtre à recréer une lumière chaude 3000°K.

\*  
 Resistente al agua a presión.  
 Apto para instalar en primera línea de mar.  
 High pressure water resistant.  
 Suitable for installation close to the sea.  
 Eau à haute pression résistant.  
 Convient pour les installations en face de la mer.



\*  
 3 tapas incluidas  
 3 covers included  
 3 couvertures inclus





# Grove

MAT Polycarbonato + ABS  
Polycarbonate + ABS  
Polycarbonate + ABS

DIF Polycarbonato  
Polycarbonate  
Polycarbonate

Blanco White Blanc + Gris Grey Gris + Negro Black Noir

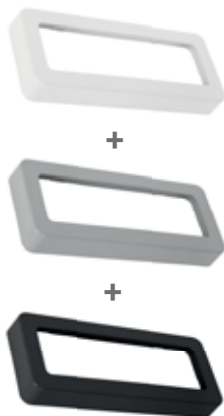

\*  
3 tapas incluidas.  
3 covers included.  
3 couvertures inclus.

PX-0281-NEG ○+●+●

**W TOTAL** 3,4W  
**LED** 3W  
400 lm  
4000°k  
Included 220-240V  
50-60Hz  
Class II  
18  
IP65  
IK10

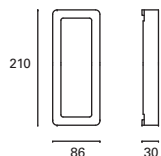

\*  
3 tapas incluidas.  
3 covers included.  
3 couvertures inclus.

PX-0129-NEG ○+●+●

**W TOTAL** 2,5W  
**LED** 2W  
400 lm  
4000°k  
Included 100-240V  
50-60Hz  
Class II  
20  
IP65  
IK10

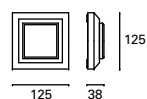

\*  
Resistente al agua a presión.  
Apto para instalar en primera línea de mar.  
High pressure water resistant.  
Suitable for installation close to the sea.  
Eau à haute pression résistant.  
Convient pour les installations en face de la mer.

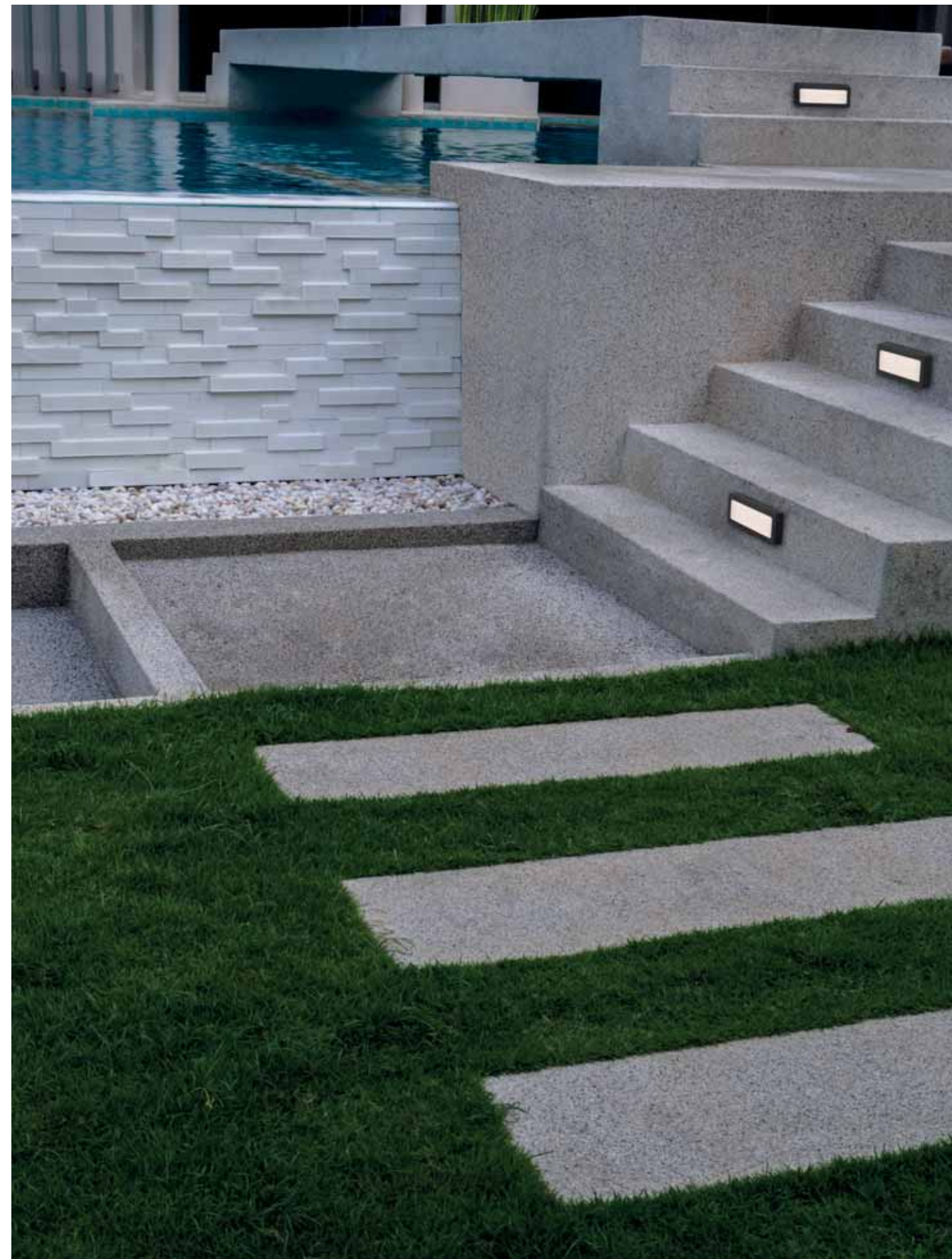





## Solar 350

MAT Policarbonato  
Polycarbonate  
Polycarbonate

DIF Policarbonato  
Polycarbonate  
Polycarbonate

● Negro  
Black  
Noir



## New flash NEW

MAT Policarbonato  
Polycarbonate  
Polycarbonate

DIF Policarbonato  
Polycarbonate  
Polycarbonate

○ Blanco  
White  
Blanc

● Negro  
Black  
Noir



PX-0507-BLA ○  
PX-0507-NEG ●

**W TOTAL** 15,8W  
**LED** 13,4W  
1500 lm  
3000°K  
Included 100-240V  
50-60Hz  
Class II  
6  
IP65  
IK10

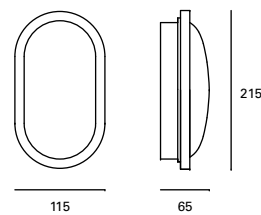

PX-0104-NEG ●

**LED** 4W  
350 lm  
6000°K  
Included 3,7V  
1200 mAh  
Class III  
8  
IP44  
IK03

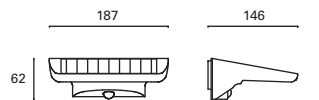

SOLAR SENSOR



Incluye sensor crepuscular y de movimiento. La duración de cada encendido es 30 segundos. Hasta 80 encendidos por noche con la batería totalmente cargada.

It includes twilight and motion sensor. Ignition duration is 30 seconds. Up to 80 ignitions per night with fully charged battery.

Il comprend capteur crépusculaire et le mouvement. La durée d'allumage est de 30 secondes. Jusqu'à 80 allumages par nuit avec une batterie complètement chargée.



Illuminación solar con batería incluida.

Solar lighting with battery.

L'éclairage solaire avec batterie.

# Litus

MAT Acero inoxidable AISI 202  
Stainless steel AISI 202  
Acier inoxydable AISI 202

DIF Policarbonato  
Polycarbonate  
Polycarbonate

Acero inoxidable  
Stainless steel  
Acier inoxydable



Ⓢ PX-0277-INO ●

**W TOTAL** 6,6W  
**LED** 5,3W  
 500 lm  
 4000°k  
 Included 100-240V  
 50-60Hz  
 Class I  
 10  
 IP44  
 IK05

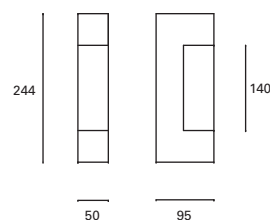

\* Incluye sensor de nocturnidad y movimiento. La duración del encendido puede ir de 10 segundos a 4 minutos. La sensibilidad también es ajustable, de 10 lux a 3000 lux. Detecta movimiento de 6m a 12m en un ángulo de 120 grados.

It includes twilight and motion sensor. Ignition duration is from 10 seconds to 4 minutes. It's also possible to adjust the sensibility, from 10 lux to 3000 lux. It detects movement from 6m to 12m and the detection angle is 120 degrees.

Le crépuscule et le capteur de mouvement sont inclus. La duration d'allumage est de 10 secondes à 4 minutes. Il est aussi possible d'ajuster la sensibilité, de 10 lux jusqu'à 3000 lux. Le mouvement peut se détecter de 6m jusqu'à 12m et l'angle de détection est de 120 degrés.



Ⓢ PX-0278-INO ●

**W TOTAL** 6,6W  
**LED** 5,3W  
 500 lm  
 4000°k  
 Included 100-240V  
 50-60Hz  
 Class I  
 10  
 IP44  
 IK05

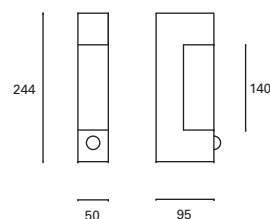





## Clock

- MAT** Acero inoxidable AISI 202  
AISI 202 Stainless steel  
Acier inoxydable AISI 202
- DIF** Policarbonato  
Polycarbonate  
Polycarbonate
- Acero inoxidable  
Stainless steel  
Acier inoxydable



PX-0279-INO ●

**W TOTAL** 8W  
**LED** 7,2W  
 770 lm  
 4000°k  
 Included 110-240VAC  
 50-60Hz  
 Class II  
 6  
 IP44  
 IK10

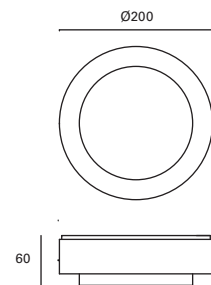

\*  
Ideal para instalar en baños gracias a su diseño y prestaciones.  
Perfect for bathrooms thanks to its performances and design.  
Idéals pour installer sur la salle de bains grâce à sa conception et prestations.

## Elix

- MAT** Acero inoxidable AISI 202  
Stainless steel AISI 202  
Acier inoxydable AISI 202
- DIF** Cristal  
Glass  
Verre
- Acero inoxidable  
Stainless steel  
Acier inoxydable



PX-0251-INO ●

**W TOTAL** 7,8W  
**LED** 6,2W  
 600 lm  
 4000°k  
 Included 100-240V  
 50-60Hz  
 Class I  
 8  
 IP44  
 IK04

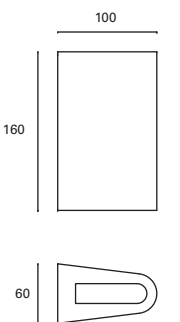
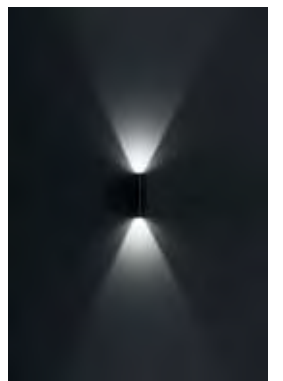

## Siluet

**MAT** Acero inoxidable AISI 304  
Stainless steel AISI 304  
Acier inoxydable AISI 304

**DIF** Policarbonato  
Polycarbonate  
Polycarbonate

Acero inoxidable  
Stainless steel  
Acier inoxydable



PX-0246-INO ●

E-27  
 Max. 60W  
 L 100 mm - Ø 60 mm  
 V/Hz 100-240V 50-60Hz  
 Class II  
 6  
 IP55  
 IK10  
 ✓

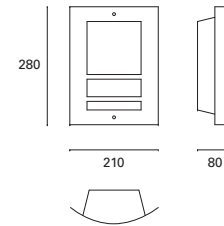

## Lord

**MAT** Acero inoxidable AISI 202  
Stainless steel AISI 202  
Acier inoxydable AISI 202

**DIF** Cristal  
Glass  
Verre

Acero inoxidable  
Stainless steel  
Acier inoxydable



PX-0273-INO ●

GU10  
 Max. 50W  
 L 70 mm  
 V/Hz 100-240V 50-60Hz  
 Class I  
 12  
 IP54  
 IK05  
 90°  
 0.2 M  
 ✓

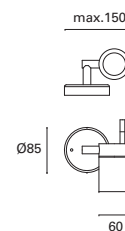

## Sirena

**MAT** Aluminio  
Aluminium  
Aluminium

**DIF** Policarbonato  
Polycarbonate  
Polycarbonate

Marrón oxido  
Rusty Brown  
Marron Rouille



PX-0063-OXI ●

E-27  
 Max. 60W  
 L 140 mm - Ø 51 mm  
 V/Hz 110-240V 50-60Hz  
 Class I  
 6  
 IP44  
 IK06  
 ✓

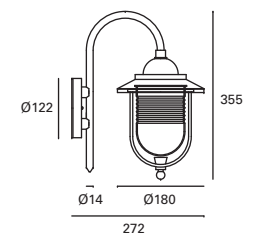



# Osaka

MAT

Acero  
Steel  
Acier

DIF

Polycarbonato  
Polycarbonate  
Polycarbonate

●

Marrón óxido  
Rusty brown  
Marron rouille



PX-0028-OXI ●

	<b>V/Hz</b>					
E27 Max.60W L 120 mm	100-240V 50-60Hz	Class I	6	IP23	IK04	✓

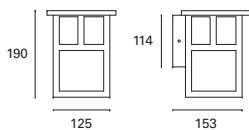





## Prisman

- MAT Aluminio Aluminium
- DIF Polipropileno Polypropylene Polypropylène
- Negro Black Noir



Ⓢ PX-0282-NEG ●

- E-27 Max.40W L 100 mm - Ø 60 mm
- V/Hz 100-240V 50-60Hz
- Class I
- 6
- IP23
- IK08
- ✓

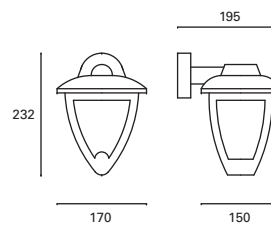

## Road

- MAT Aluminio Aluminium
- DIF Polipropileno Polypropylene Polypropylène
- Negro Black Noir



Ⓢ PX-0280-NEG ●

- E-27 Max.60W L 120 mm - Ø 80 mm
- V/Hz 100-240V 50-60Hz
- Class I
- 12
- IP23
- IK05
- ✓

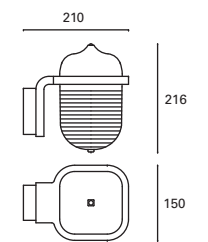



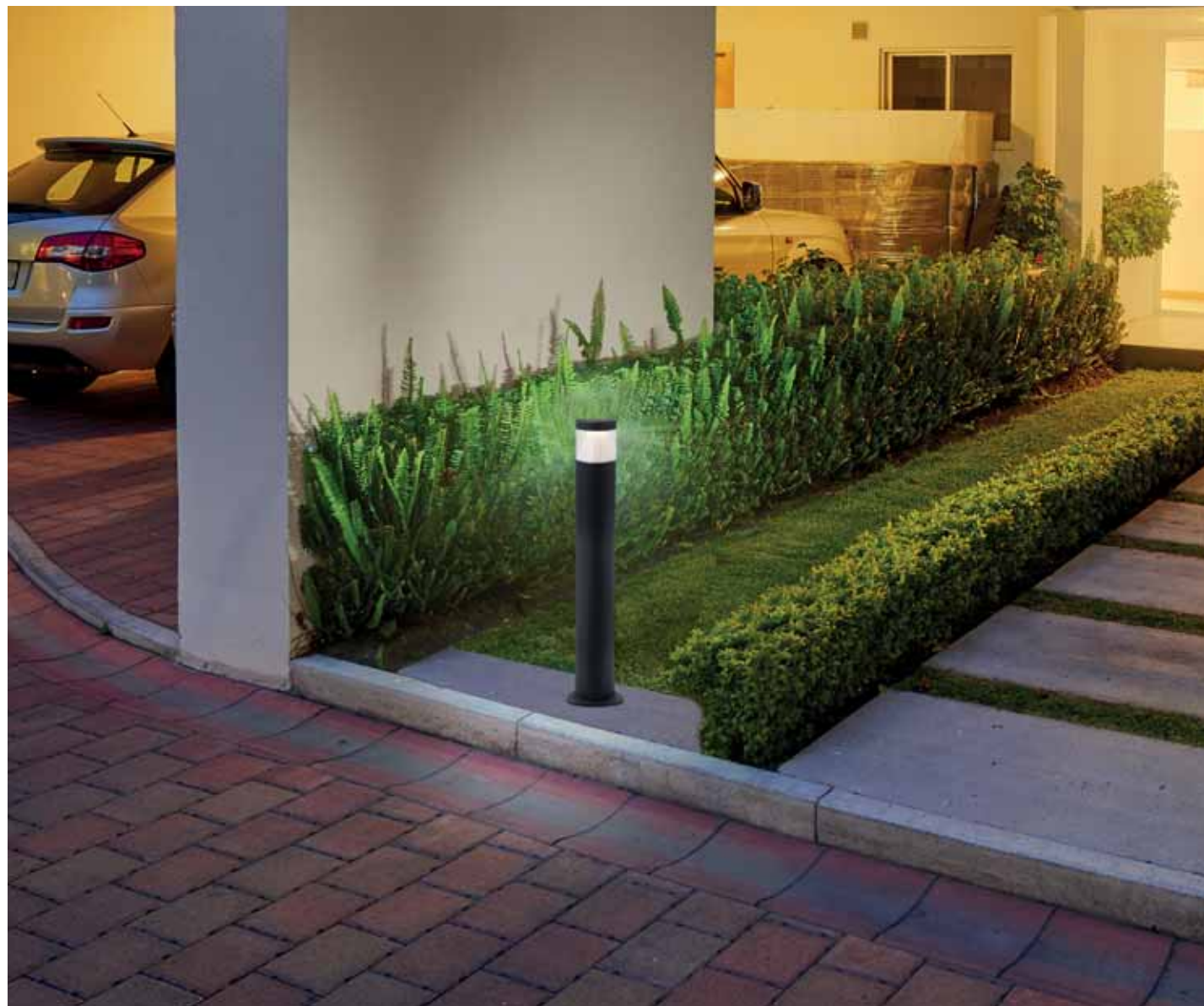

## Arrow

- MAT: Aluminio / Aluminium / Aluminium
- DIF: Policarbonato / Polycarbonate / Polycarbonate
- Color: Negro / Black / Noir



PX-0139-NEG ●

**W TOTAL** 6,6W  
**LED** 5,5W 640 lm  
 3000°k  
 Included 100-240V 50-60Hz  
 Class I  
 9  
 IP65  
 IK09

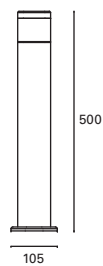

## Zip NEW

- MAT: Aluminio / Aluminium / Aluminium
- DIF: Policarbonato opal / Opal Polycarbonate / Polycarbonate opal
- Color: Gris urbano / Urban grey / Gris urbain



PX-0515-ANT ●

**W TOTAL** 3W  
**LED** 3W 310 lm  
 2700°k  
 6000°k  
 \* RGB  
 Included 220-240V 50-60Hz  
 Class II  
 4  
 IP54  
 IK10

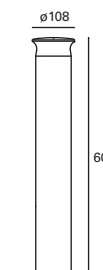

\* **WARM&COOL:** Permite ajustar la intensidad y la temperatura de color de la luz desde blanco cálido hasta blanco frío. Allows you to adjust the light intensity and colour temperature, from warm white to cool white. Permet de régler l'intensité et la température de couleur de la lumière, du blanc chaud au blanc froid



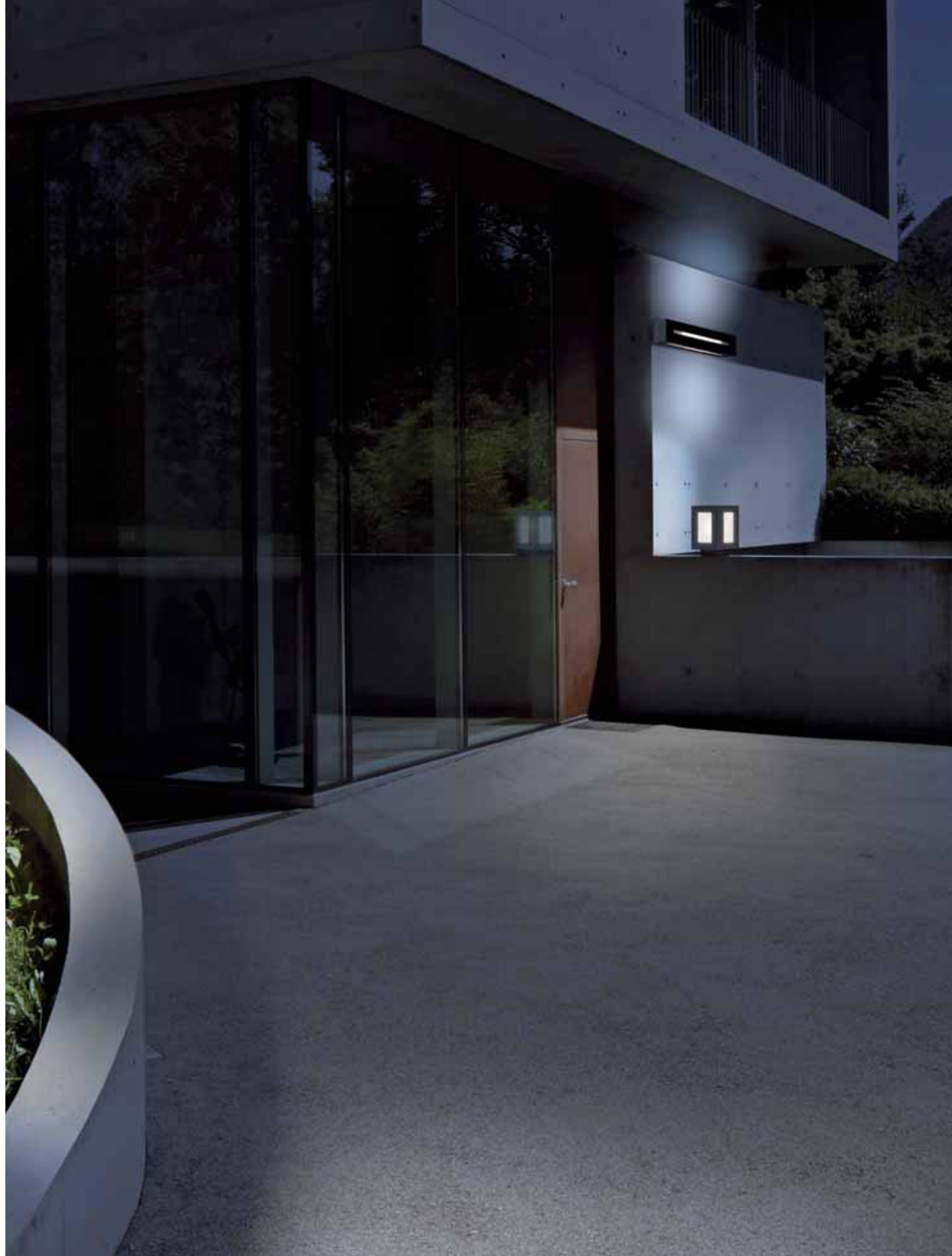

**Alfil** NEW

MAT Aluminio  
Aluminium  
Aluminium

DIF Cristal  
Glass  
Verre

● Gris urbano  
Urban grey  
Gris urbain



**PX-0034-ANT** ●

E-27  
Max. 23W  
L 130 mm -  
Ø 45 mm
 **V/Hz**  
100-240V  
50-60Hz
 Class I
 6
 IP44

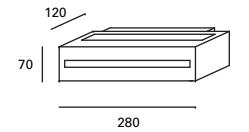

**PX-0033-ANT** ●

E-27  
Max. 23W  
L 110 mm
 **V/Hz**  
100-240V  
50-60Hz
 Class I
 4
 IP44

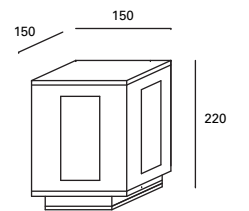





## Yika

- MAT Policarbonato + ABS  
Polycarbonate + ABS  
Polycarbonate + ABS
- DIF Policarbonato  
Polycarbonate  
Polycarbonate
- Negro  
Black  
Noir



PX-0486-NEG ●

<b>W TOTAL</b> 7,9W	<b>LED</b> 6,3W 690 lm 3000°k	Included 100-240V 50-60Hz	Class II	12	IP44	Sea Side Suitable	IK08	
------------------------	--	---------------------------------	----------	----	------	-------------------	------	--

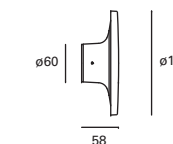

PX-0487-NEG ●

<b>W TOTAL</b> 7,9W	<b>LED</b> 6,3W 690 lm 3000°k	Included 100-240V 50-60Hz	Class II	6	IP44	Sea Side Suitable	IK08	
------------------------	--	---------------------------------	----------	---	------	-------------------	------	--

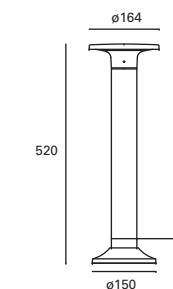

\*  
Apto para instalar en primera línea de mar.  
Suitable for installation close to the sea.  
Convient pour les installations en face de la mer.





## Mandela

- MAT Aluminio  
Aluminium  
Aluminium
- DIF Policarbonato  
Polycarbonate  
Polycarbonate
- Gris urbano  
Urban grey  
Gris urbain



PX-0086-ANT ●

- E27  
Max.23W  
L 150 mm
- V/Hz  
100-240V  
50-60Hz
- Class I
- 6
- IP44
- IK08
- ✓

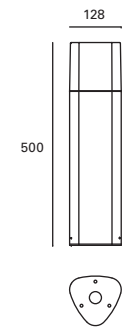

PX-0087-ANT ●

- E27  
Max.23W  
L 150 mm
- V/Hz  
100-240V  
50-60Hz
- Class I
- 6
- IP44
- IK08
- ✓

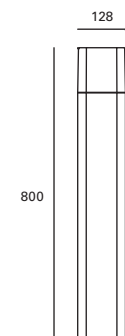



# Koral

**MAT** Acero inoxidable AISI 202  
AISI 202 Stainless steel  
Acier inoxydable AISI 202

**DIF** Policarbonato  
Polycarbonate  
Polycarbonate

Blanco  
White  
Blanc

Marrón  
Brown  
Marron

Gris urbano  
Urban grey  
Gris urbain

Acero inoxidable  
Stainless steel  
Acier inoxydable



- Ⓢ PX-0099-BLA ○
- Ⓢ PX-0099-MAR ●
- PX-0099-ANT ●
- PX-0099-INO ●

E27 Max.23W L 167 mm - Ø 55 mm  
 V/Hz 100-240V 50-60Hz  
 Class I  
 4  
 IP55  
 IK10  
 ✓

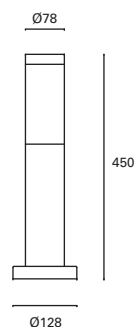

- PX-0100-ANT ●
- PX-0100-INO ●

E27 Max.23W L 167 mm - Ø 55 mm  
 V/Hz 100-240V 50-60Hz  
 Class I  
 4  
 IP55  
 IK10  
 ✓

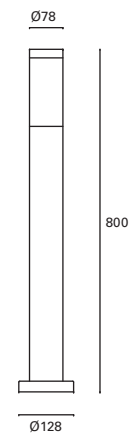

- Ⓢ PX-0098-BLA ○
- Ⓢ PX-0098-MAR ●
- PX-0098-ANT ●
- PX-0098-INO ●

E27 Max.23W L 167 mm - Ø 55 mm  
 V/Hz 100-240V 50-60Hz  
 Class I  
 12  
 IP55  
 IK10  
 ✓

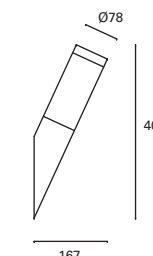

\*  
Resistente al agua a presión.  
High pressure water resistant.  
Eau à haute pression résistant.

# Siljan

**MAT** Acero inoxidable AISI 202  
AISI 202 Stainless steel  
Acier inoxydable AISI 202

**DIF** Policarbonato  
Polycarbonate  
Polycarbonate

**Marrón**  
Brown  
Marron



**PX-0029-MAR**

**E27**  
Max. 20W  
L 140 mm -  
Ø 42 mm

**V/Hz** 100-240V  
50-60Hz

**Class I**

**12**

**IP55**

**IK08**

✓

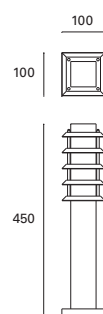

**PX-0030-MAR**

**E27**  
Max. 20W  
L 140 mm -  
Ø 42 mm

**V/Hz** 100-240V  
50-60Hz

**Class I**

**6**

**IP55**

**IK08**

✓

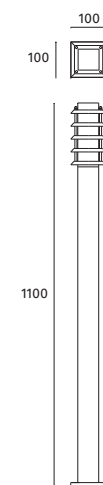

**PX-0031-MAR**

**E27**  
Max. 20W  
L 140 mm -  
Ø 42 mm

**V/Hz** 100-240V  
50-60Hz

**Class I**

**12**

**IP55**

**IK08**

✓

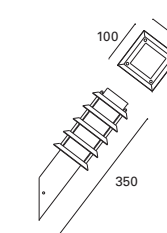

\*  
Resistente al agua a presión.  
High pressure water resistant.  
Eau à haute pression résistant.



# Avenue

MAT Acero Steel Acier

DIF Cristal Glass Verre

● Negro Black Noir



Ⓢ PX-0252-NEG ●

E-27  
 Max. 60W  
 100-240V  
 50-60Hz  
 Class I  
 IP44  
 4  
 ✓

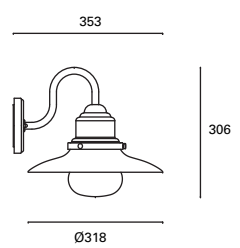



# Siros

MAT Aluminio Aluminium Aluminium

DIF Cristal burbuja Bubbled glass Verre à bulles

Marrón óxido Rusty brown Marron rouille



PX-0025-OXI ●

E27 Max.100W L 180 mm | V/Hz 100-240V 50-60Hz | Class I | 6 | IP23 | IK02 | ✓



350

Ø220



PX-0024-OXI ●

E27 Max.100W L 180 mm | V/Hz 100-240V 50-60Hz | Class I | 4 | IP23 | IK02 | ✓



440

Ø220

350



PX-0026-OXI ●

E27 Max.100W L 180 mm | V/Hz 100-240V 50-60Hz | Class I | 6 | IP23 | IK02 | ✓



650

Ø220



PX-0027-OXI ●

2xE27 Max.100W L 180 mm | V/Hz 100-240V 50-60Hz | Class I | 1 | IP23 | IK02 | ✓

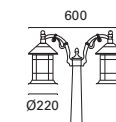

2080

600

Ø220



# Adur

MAT Aluminio inyectado  
Injected aluminium  
Aluminium injecté

DIF Cristal  
Glass  
Verre

Marrón óxido  
Rusty brown  
Marron rouille



PX-0240-OXI ●

E27  
 Max. 100W  
 L 167 mm  
 V/Hz  
 100-240V  
 50-60Hz  
 Class I  
 4  
 IP23  
 IK05  
 ✓

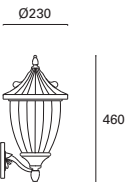

PX-0241-OXI ●

E27  
 Max. 100W  
 L 167 mm  
 V/Hz  
 100-240V  
 50-60Hz  
 Class I  
 4  
 IP23  
 IK05  
 ✓

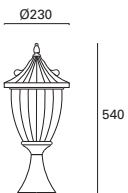





# Decorativo Decorative Décoratif



# Bowl NEW

MAT Acero Steel Acier

Negro Black Noir



**DE-0488-NEG ●**

E-27  
 Max. 40W  
 L 170mm  
**V/Hz**  
 100-240V  
 50-60Hz  
 Class I  
 2  
 V

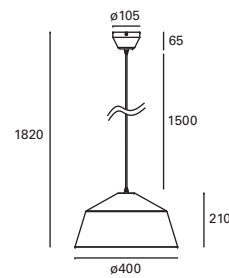

\*  
 Regulable en altura hasta 182 cm.  
 Height adjustable up to 182 cm.  
 Réglable en hauteur jusqu'à 182 cm.



**DE-0508-NEG ●**

E-27  
 Max. 40W  
 L 94 mm-  
 Ø 240 mm  
**V/Hz**  
 100-240VAC  
 50-60Hz  
 Class I  
 4  
 IP20

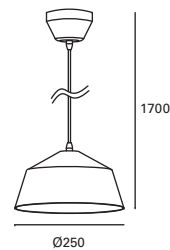

\*  
 Regulable en altura hasta 170 cm.  
 Height adjustable up to 170 cm.  
 Réglable en hauteur jusqu'à 170 cm.



**Thin** NEW

MAT Aluminio Aluminium

● Negro Black Noir

○ Blanco White Blanc

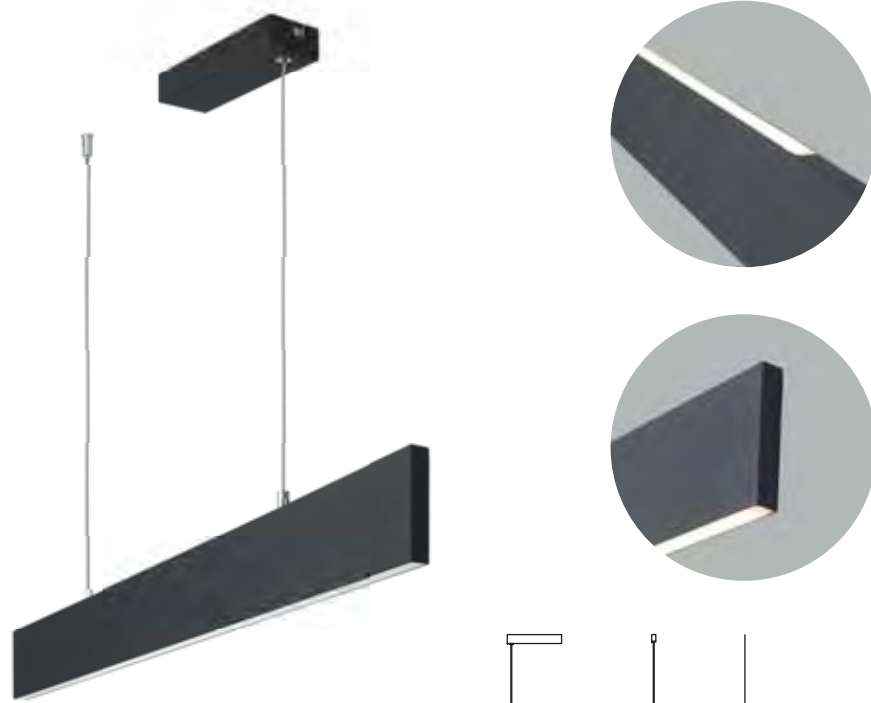

**DE-0510-NEG ●**

**W TOTAL** 25,9W  
**LED** 22,9W 1950 lm 3000°K  
 Included 220-240V 50-60Hz  
 Class II 6

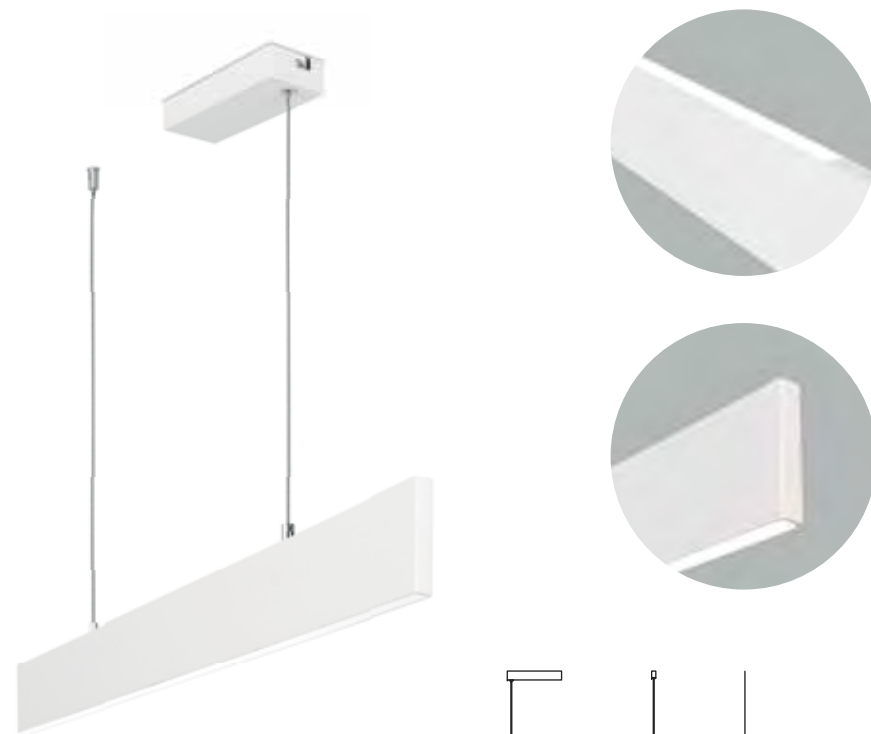
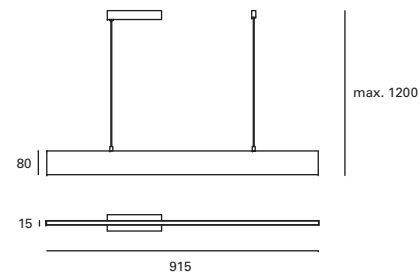

**DE-0510-BLA ○**

**W TOTAL** 25,9W  
**LED** 22,9W 1950 lm 3000°K  
 Included 220-240V 50-60Hz  
 Class II 6

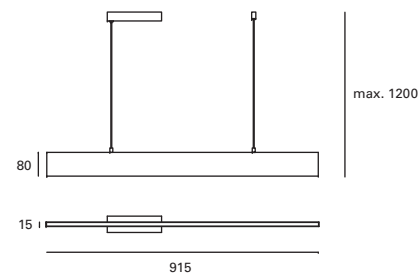

\* Iluminación hacia arriba y hacia abajo.  
 Up lighting and down lighting.  
 Éclairage vers le haut et vers le bas.





# King

MAT Cemento  
Cement  
Ciment

Gris  
Grey  
Gris



\*  
Accesorio extraíble.  
Removable accessory.  
Accessoire amovible.

DE-0265-CEM ●

E-27  
Max. 60W  
L 110 mm -  
Ø 110 mm

V/Hz  
100-240V  
50-60Hz

Class I

4

✓

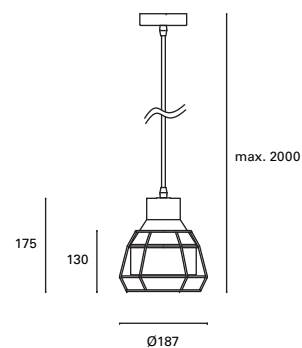

\*  
Regulable en altura hasta 200 cm.  
Height adjustable up to 200 cm.  
Réglable en hauteur jusqu'à 200 cm.



# Bloom NEW

MAT Cemento Cement Ciment

Cemento Cement Ciment

Rosa Pink Rose

Verde Green Verde



**DE-0518-CEM** ●

E-27  
 Max. 23W  
**V/Hz**  
 100-240V  
 50-60Hz  
 Class I  
 8  
 ✓

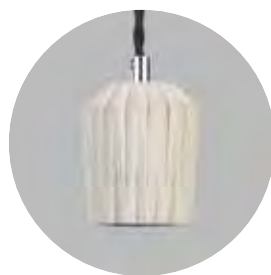
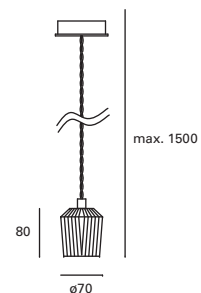

**DE-0519-CEM** ●

E-27  
 Max. 23W  
**V/Hz**  
 100-240V  
 50-60Hz  
 Class I  
 8  
 ✓

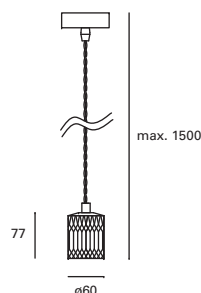

**DE-0520-CEM** ●

E-27  
 Max. 23W  
**V/Hz**  
 100-240V  
 50-60Hz  
 Class I  
 8  
 ✓

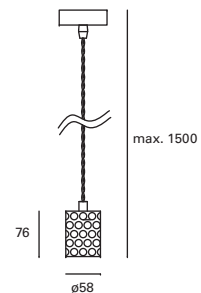

\*  
 Regulable en altura hasta 150 cm.  
 Height adjustable up to 150 cm.  
 Réglable en hauteur jusqu'à 150 cm.





# Nube

MAT Acero Steel Acier

Rojo teja Brick red Rouge tuile

Gris marengo Charcoal grey Gris marengo

Blanco White Blanc

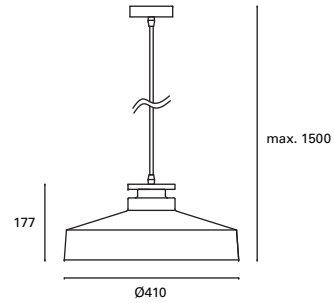

DE-0234-RTJ ●

E-27 Max. 40W L 110 mm | V/Hz 100-240V 50-60Hz | Class I | 2 | √

\* Regulable en altura hasta 150 cm.  
Height adjustable up to 150 cm.  
Réglable en hauteur jusqu'à 150 cm.



\*  
Detalle en madera natural.  
Detail in natural wood.  
Détail en bois naturel.

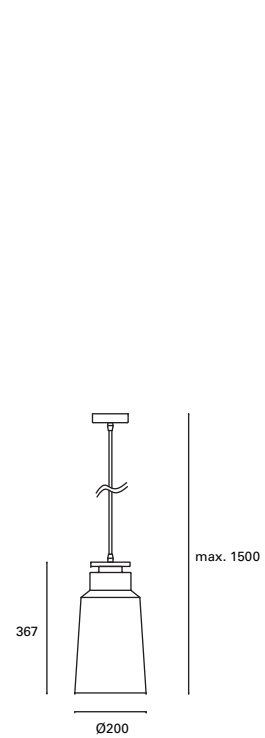

DE-0235-AZP ●

E-27 Max. 40W Ø 150 mm | V/Hz 100-240V 50-60Hz | Class I | 2 | √

\* Regulable en altura hasta 175 cm.  
Height adjustable up to 175 cm.  
Réglable en hauteur jusqu'à 175 cm.



\*  
Detalle en madera natural.  
Detail in natural wood.  
Détail en bois naturel.

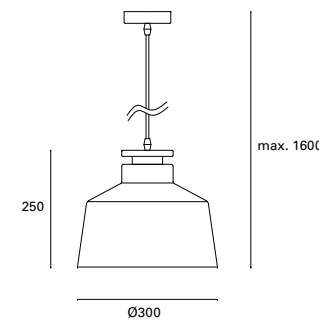

DE-0233-BLA ○

E-27 Max. 40W L 200 mm | V/Hz 100-240V 50-60Hz | Class I | 4 | √

\* Regulable en altura hasta 160 cm.  
Height adjustable up to 160 cm.  
Réglable en hauteur jusqu'à 160 cm.



\*  
Detalle en madera natural.  
Detail in natural wood.  
Détail en bois naturel.

# Vira

MAT Acero Steel Acier

Blanco White Blanc

Negro Black Noir



\*  
 Detalles en acabado cromado.  
 Details in chrome finish.  
 Détails en finition chrome.



DE-0180-BLA ○  
 DE-0180-NEG ●

Regulable  
 GU10 Max. 7W L 58 mm - Ø 50 mm  
 V/Hz 100-240V 50-60Hz  
 Class I  
 12

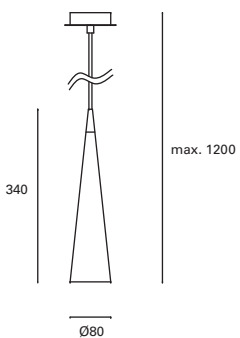

\*  
 Regulable en altura hasta 120 cm.  
 Height adjustable up to 120 cm.  
 Réglable en hauteur jusqu'à 120 cm.



## Dixie

MAT Aluminio Aluminium Aluminium

Oro Gold Or

Cobre Copper Cuiver



DE-0267-ORO ●  
DE-0267-COR ●

✳️  
Regulable en altura hasta 200 cm.  
Height adjustable up to 200 cm.  
Réglable en hauteur jusqu'à 200 cm.

E-27  
 Max. 60W  
 V/Hz  
 100-240V  
 50-60Hz  
 Class I  
 8  
 ✓

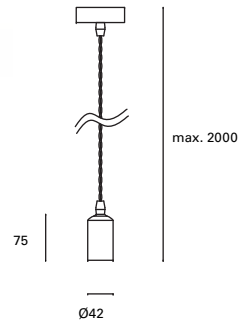

## Pray

MAT Acero Steel Acier

Negro Black Noir



Ⓢ DE-0182-NEG ●

✳️  
Regulable en altura hasta 120 cm.  
Height adjustable up to 120 cm.  
Réglable en hauteur jusqu'à 120 cm.

E-27  
 Max. 60W  
 L 130 mm -  
 Ø 85 mm  
 V/Hz  
 100-240V  
 50-60Hz  
 Class I  
 24  
 ✓

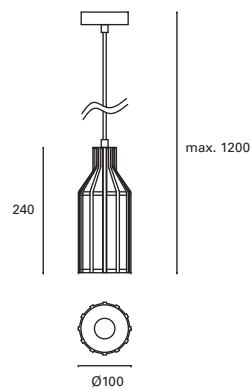

## Mar

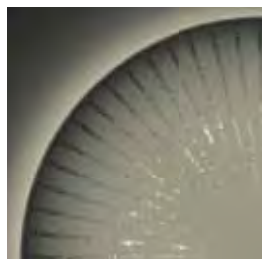
Acero  
Steel  
AcierCristal  
Glass  
VerreBlanco  
White  
Blanc

S DE-0311-CRI ○

W  
TOTAL  
18,8WLED  
16,2W  
1880 lm  
3000°K Included  
100-240V  
50-60Hz

Class I



5



✓

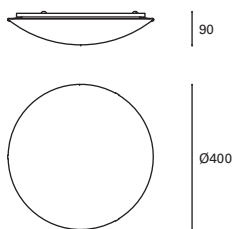



# Tempo

- MAT Aluminio Aluminium Aluminium
- DIF Acrílico Acrylic Acrylique
- Aluminio Aluminium Aluminium



DE-0313-ALU ○

**W TOTAL** 18,8W | **LED** 16,2W 1880 lm 3000°K | Included 100-240V 50-60Hz | Class II IP44 5 ✓

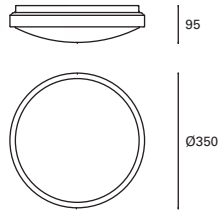

DE-0314-ALU ○

**W TOTAL** 25,3W | **LED** 22,8W 2300 lm 3000°K | Included 100-240V 50-60Hz | Class I IP23 5 ✓

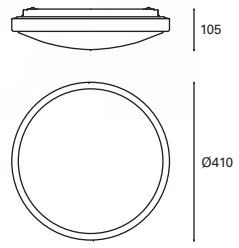

## Olra

Acero  
Steel  
AcierAcrílico  
Acrylic  
AcryliqueBlanco  
White  
Blanc

DE-0198-BLA ○

**W TOTAL** 22,8W  
**LED** 20,3W  
 2400 lm  
 3000°K

Included 100-240V 50-60Hz  
 Class I  
 10  
 IP23  
 ✓



N DE-0513-BLA ○

**W TOTAL** 24,2W  
**LED** 21W  
 2160 lm  
 2700°K  
 6000°K

WiFi  
 Included 230V 50-60Hz  
 Class II  
 10  
 IP20  
 ✓

\*

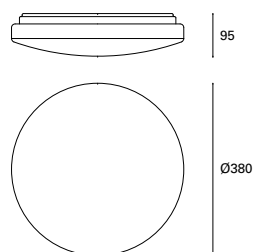

\* **WARM&COOL:** Permite ajustar la intensidad y la temperatura de color de la luz desde blanco cálido hasta blanco frío. Allows you to adjust the light intensity and colour temperature, from warm white to cool white. Permet de régler l'intensité et la température de couleur de la lumière, du blanc chaud au blanc froid

## Farrow

Acero  
Steel  
AcierCristal  
Glass  
VerreBlanco  
White  
Blanc

DE-0199-BLA ○

2xE-27  
 Max. 40W  
 L 140 mm -  
 Ø 60 mm

**V/Hz** 100-240V  
 50-60Hz  
 Class I  
 4  
 ✓

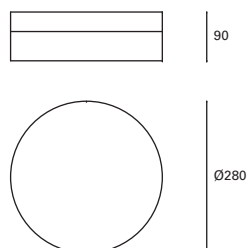



## Bas

- MAT Acero  
Steel  
Acier
- DIF Cristal  
Glass  
Verre
- Níquel satinado  
Satin nickel  
Nickel satiné



**DE-0442-SAT** ●

**W TOTAL** 4,3W  
**LED** 3,8W  
 450 lm  
 3000°K

Included 100-240V 50-60Hz  
 Class I 20

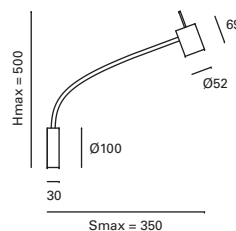

## Crobat

- MAT Policarbonato  
Polycarbonate  
Polycarbonate
- DIF Policarbonato  
Polycarbonate  
Polycarbonatee
- Blanco White  
White  
Blanc
- Negro Black  
Black  
Noir



**DE-0268-NEG** ●

**W TOTAL** 4,3W  
**LED** 3,8W  
 450 lm  
 3000°K

Included 100-240V 50-60Hz  
 Class II 12 ✓

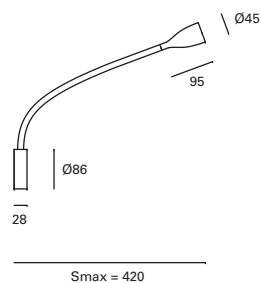

**DE-0268-BLA** ○

**W TOTAL** 4,3W  
**LED** 3,8W  
 450 lm  
 3000°K

Included 100-240V 50-60Hz  
 Class II 12 ✓

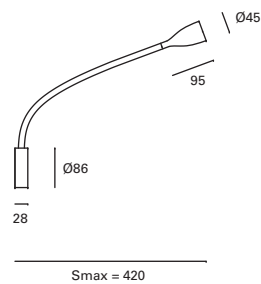

\*  
 Detalles en acabado cromado.  
 Details in chrome finish.  
 Détails en finition chrome.



**Thin** NEW

**MAT** Aluminio  
Aluminium  
Aluminium

**DIF** Tecnopolímero  
Technopolymer  
Technopolymère

Blanco  
White  
Blanc

Negro  
Black  
Noir

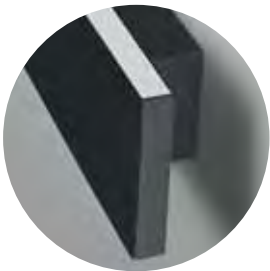

**DE-0509-NEG ●**

**W** TOTAL 7,8W  
**LED** 6,4W  
860 lm  
3000°K  
Included 220-240V  
50-60Hz  
Class II  
10

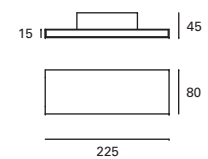

**DE-0509-BLA ○**

**W** TOTAL 7,8W  
**LED** 6,4W  
860 lm  
3000°K  
Included 220-240V  
50-60Hz  
Class II  
10

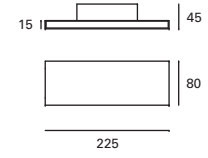



# Keop

MAT Aluminio Aluminium

Blanco White Blanc

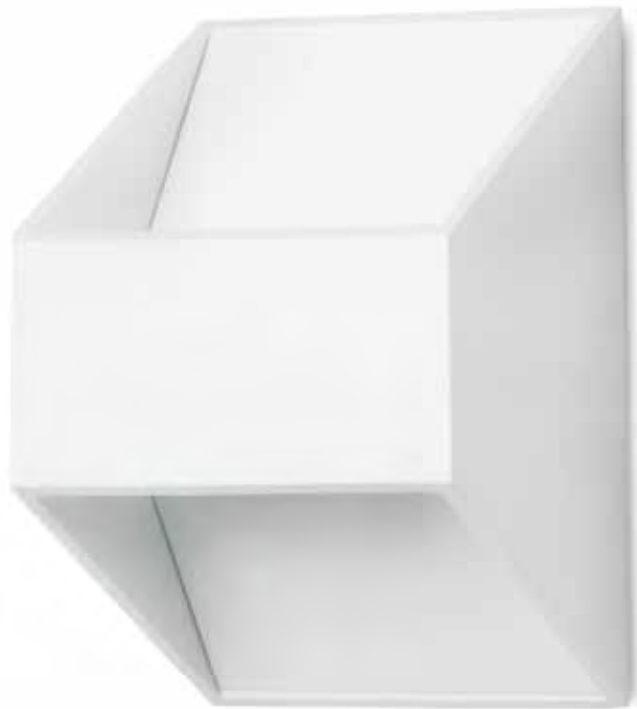

DE-0229-BLA ○

**W TOTAL** 5,8W  
**LED** 4,6W  
420 lm  
3000°K  
Included 100-240V 50-60Hz  
Class I  
20  
✓

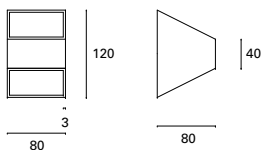

## Toppi

MAT Aluminio Aluminium Aluminium

Blanco White Blanc



DE-0231-BLA ○

**W TOTAL** 5,8W | **LED** 4,7W 530 lm 3000°K | Included 100-240V 50-60Hz | Class II | 20 | ✓

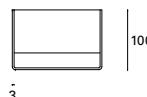
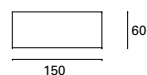

DE-0232-BLA ○

**W TOTAL** 11,5W | **LED** 9,4W 1100 lm 3000°K | Included 100-240V 50-60Hz | Class II | 20 | ✓

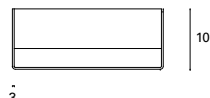
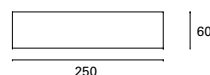

## Cuadro

MAT Aluminio Aluminium Aluminium

DIF Cristal Glass Verre

Blanco White Blanc



DE-0424-BLA ○

**W TOTAL** 5,8W | **LED** 4,5W 300 lm 3000°K | Included 100-240V 50-60Hz | Class II | 50 | ✓

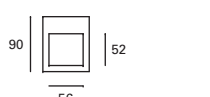
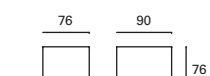
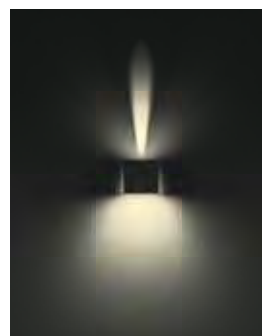



# Romi

- MAT Acero  
Steel  
Acier
- DIF Tela Blanca  
White Cloth  
Chiffon blanc
- Níquel satinado  
Satin nickel  
Nickel satiné



**DE-0381-SAT** ●

E-27  
Max. 40W  
L 180 mm

**V/Hz**  
100-240V  
50-60Hz

Class I 6

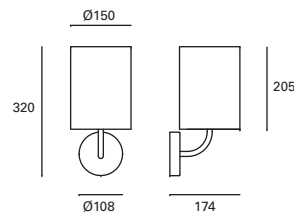

**DE-0382-SAT** ●

E-27  
Max. 40W  
L 180 mm

**W TOTAL**  
2,8W

**LED**  
2,2W  
175 lm  
3000°k

Included  
100-240V  
50-60Hz

Class I 6

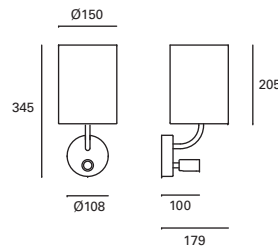

**DE-0383-SAT** ●

E-27  
Max. 40W  
L 180 mm

**V/Hz**  
100-240V  
50-60Hz

Class II 6

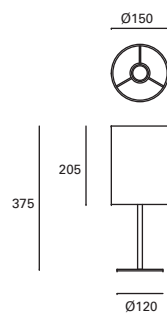

**\***  
Lector LED con interruptor independiente.  
LED reader with independents witch.  
Lecteur LED avec interrupteur indépendant.

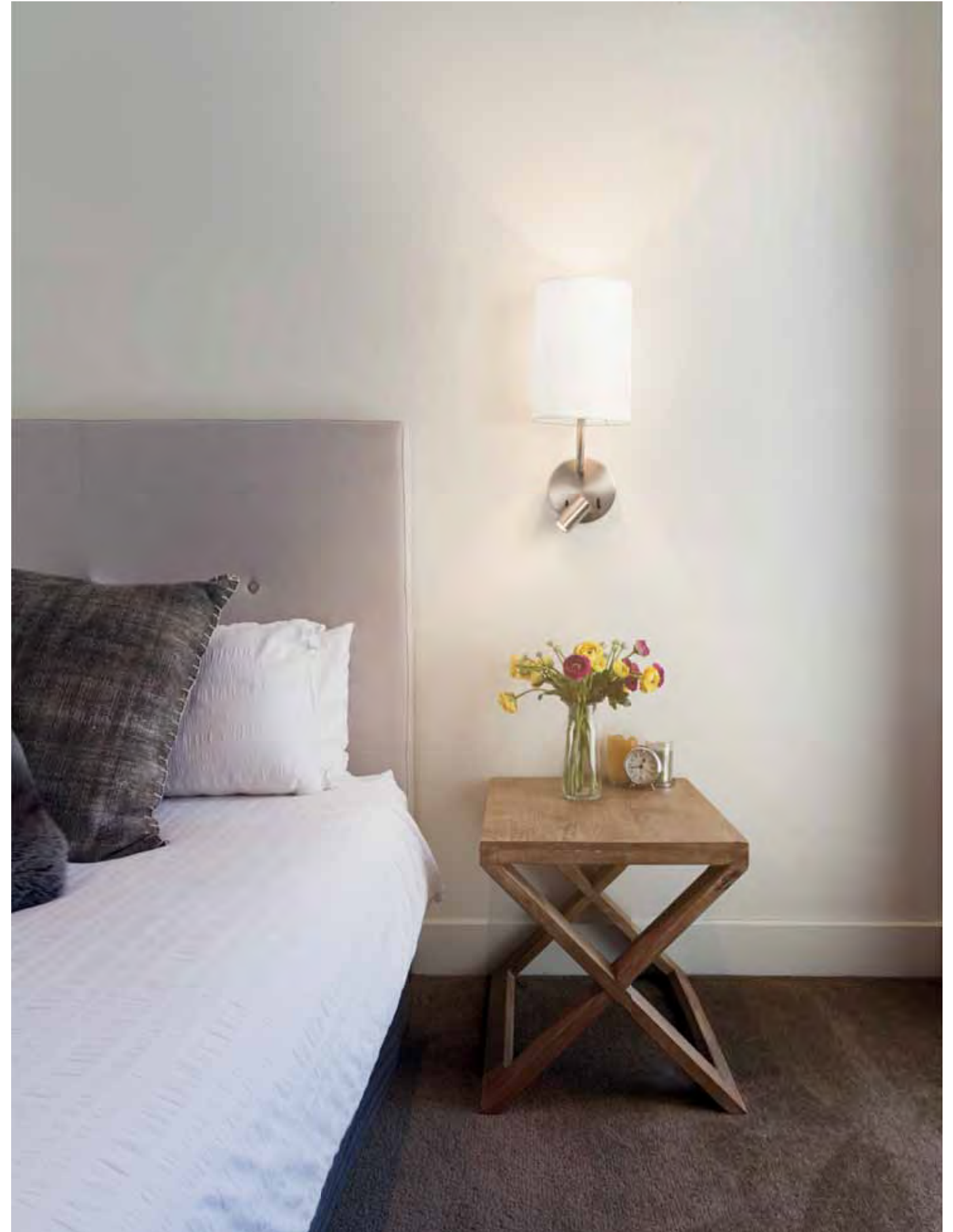

## Mush NEW

MAT Aluminio Aluminium Aluminium

DIF Policarbonato Polycarbonate Polycarbonate

Blanco White Blanc

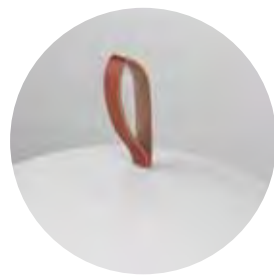

\* Cuero. Leather. Encuir.



PX-0528-BLA ○

W TOTAL 2W  
**LED** 2W 200 lm 3000°k  
 Included 5VDC 1000 mA  
 Class III 4

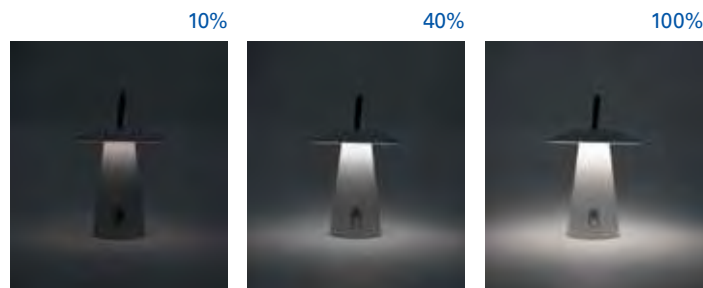
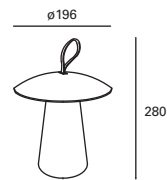

3 intensidades luminicas. 3 brightness settings. 3 intensités lumineuses.

\* Duración de la batería: 6,5h 100%, 15h 40% y 80h 10%.  
 Battery duration: 6,5h 100%, 15h 40% and 80h 10%.  
 Duréedelabatterie: 6,5h 100%, 15h 40% et 80h 10%.



\* ON/OFF táctil. ON/OFF touch switch. ON/OFF tactile.



\* Cable USB tipo C de 1 metro incluido. 1 metre USB C-type cable included. Câble USB type C de 1 mètre fourni.

## Magnet NEW

MAT Acero / Aluminio Stainless / Aluminium Acier / Aluminium

DIF Policarbonato opal Opal polycarbonate Polycarbonate opale

Negro Black Noir



PX-0529-NEG ●

W TOTAL 1,5W  
**LED** 1,5W 280 lm 3000°k  
 Included 100-240V 50-60Hz  
 Class III 8

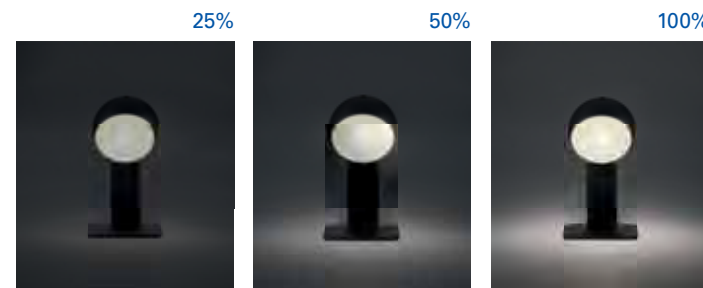
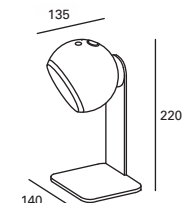

3 intensidades luminicas. 3 brightness settings. 3 intensités lumineuses.

\* Duración de la batería: 5h 100%, 10h 50% y 20h 25%.  
 Battery duration: 5h 100%, 10h 50% and 20h 25%.  
 Durée de la batterie: 5h 100%, 10h 50% et 20h 25%.



\* Cabezal orientable y extraíble gracias a su sistema de fijación magnético. Adjustable, removable head thanks to its magnetic fixing system. Tête orientable et amovible grâce à son système de fixation magnétique.



\* Cable USB tipo C de 1,2 metros incluido. 1.2 metres USB C-type cable included. Câble USB type C de 1,2 mètre fourni.



# Night

- MAT Aluminio  
Aluminium  
Aluminium
- DIF Policarbonato  
Polycarbonate  
Polycarbonate
- Blanco  
White  
Blanc

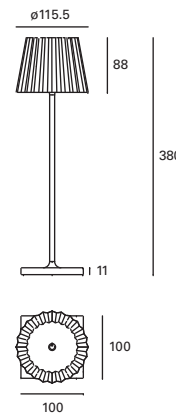

DE-0474-BLA ○

<b>W</b> TOTAL 6,5W	<b>LED</b> 1,3W 280 lm 3000°k	Included 100-240V 50-60Hz	Class II	6	IP54	IK10	✓
---------------------------	--	---------------------------------	----------	---	------	------	---



\*  
Duración de la batería: 9 horas.  
Cargador incluido.  
Battery duration: 9 hours.  
Charger included.  
Durée de la batterie: 9 heures.  
Chargeur inclus.



\*  
ON/OFF táctil.  
ON/OFF touch switch.  
ON/OFF tactile.

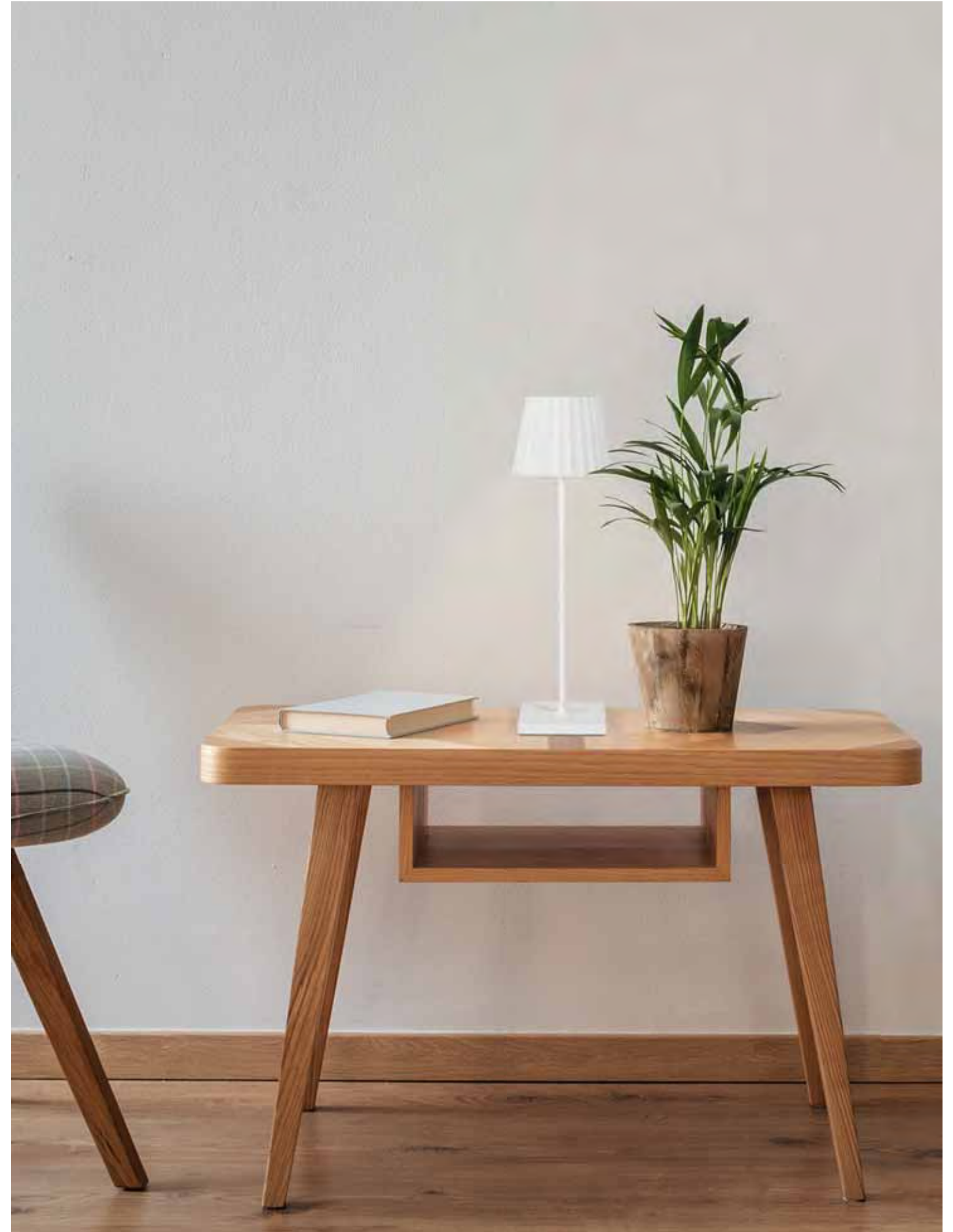

# Sphere

MAT Polycarbonato  
Polycarbonate  
Polycarbonate

DIF Polietileno  
Polyethylene  
Polyéthylène

● Negro  
Black  
Noir



DE-0490-NEG ●

<b>W</b> TOTAL 1,5W	<b>LED</b> 1,5W 90 m 2700°k	Not included Recommended: 5V1A	Class III	8	IP44	IK10	1,2 m	√
---------------------------	--------------------------------------	--------------------------------------	-----------	---	------	------	-------	---

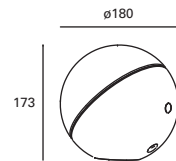

\*  
Cable cargador  
de 1,2 metros incluido.  
1,2 meters charging cable  
included.  
Câble de chargeur  
de 1,2 mètres inclus.

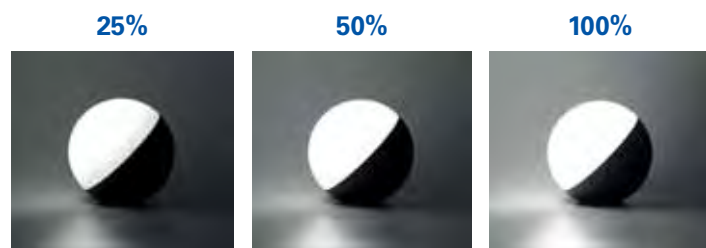

3 intensidades luminicas.  
3 brightness settings.  
3 intensités lumineuses.

\*  
Duración de la batería: 5 horas (100%).  
Battery duration: 5 hours (100%).  
Durée de la batterie: 5 heures (100%).





# Touch NEW

MAT Aluminio Aluminium Aluminium

DIF Policarbonato Polycarbonate Polycarbonate

Blanco White Blanc

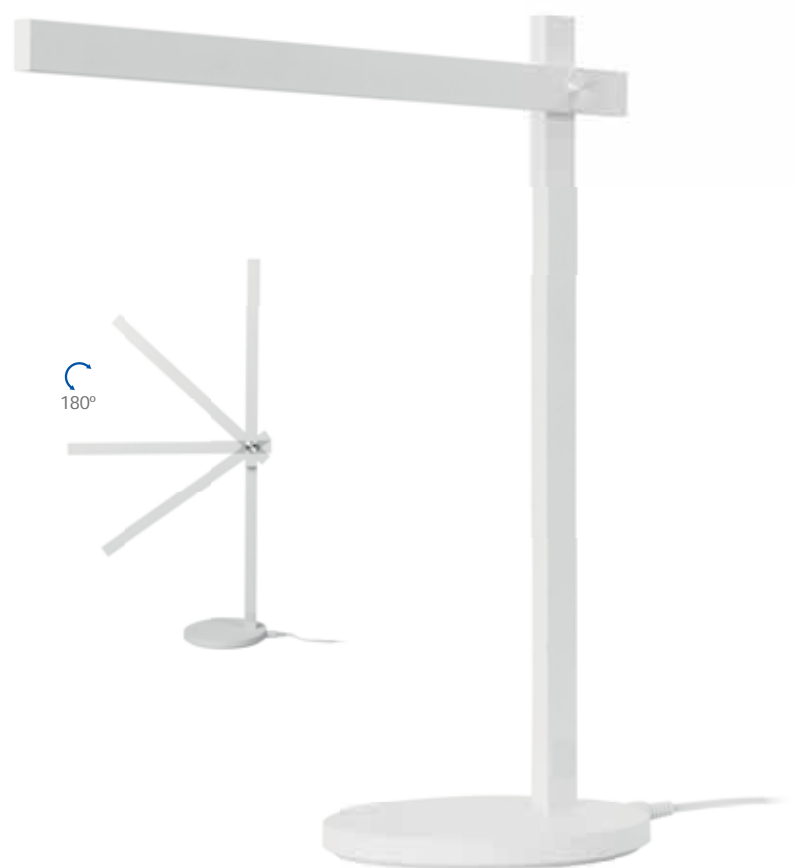

DE-0477-BLA ○

<b>W TOTAL</b> 6,4W	<b>LED</b> 5W 680 lm 3000°K 4300°K 6500°K	Touch DIM	Included 100-240VAC 50-60Hz	Class II	6	180°	✓
------------------------	--	-----------	-----------------------------------	----------	---	------	---

DE-0492-BLA ○

<b>W TOTAL</b> 6,4W	<b>LED</b> 5W 680 lm 3000°K 4300°K 6500°K	Wireless charger 5v 1A (máx.5W)	Touch DIM	Included 100-240VAC 50-60Hz	Class II	6	180°	✓
------------------------	--	---------------------------------------	-----------	-----------------------------------	----------	---	------	---



\*  
Regulación táctil de intensidad y temperatura de color.  
Touch dimmer to adjust brightness and colour temperature.  
Réglage tactile de l'intensité et la température de couleur.



\*  
Detalles en acabado cromado.  
Details in chrome finish.  
Détails en finition chrome.



\*  
El código DE-0492-BLA incluye cargador inalámbrico.  
The code DE-0492-BLA includes wireless charger.  
Le code DE-0492-BLA comprend un chargeur sansfil.

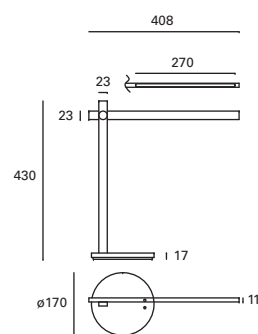

3 temperaturas de color (3000K/4300K/6500K).  
3 colour temperatures (3000K/4300K/6500K).  
3 températures de couleur (3000K/4300K/6500K).

3 intensidades lumínicas.  
3 brightness settings.  
3 intensités lumineuses.

# Tender NEW

**MAT** Polycarbonato + Acero  
Polycarbonate + Steel  
Polycarbonate + Acier

**DIF** Polycarbonato  
Polycarbonate  
Polycarbonate

**○** Blanco  
White  
Blanc

**●** Negro  
Black  
Noir



DE-0500-BLA ○  
DE-0500-NEG ●

**W**  
TOTAL  
4,6W

**LED**  
4W  
550 lm  
3000°K

Included  
100-240V  
50-60Hz

Class II

6

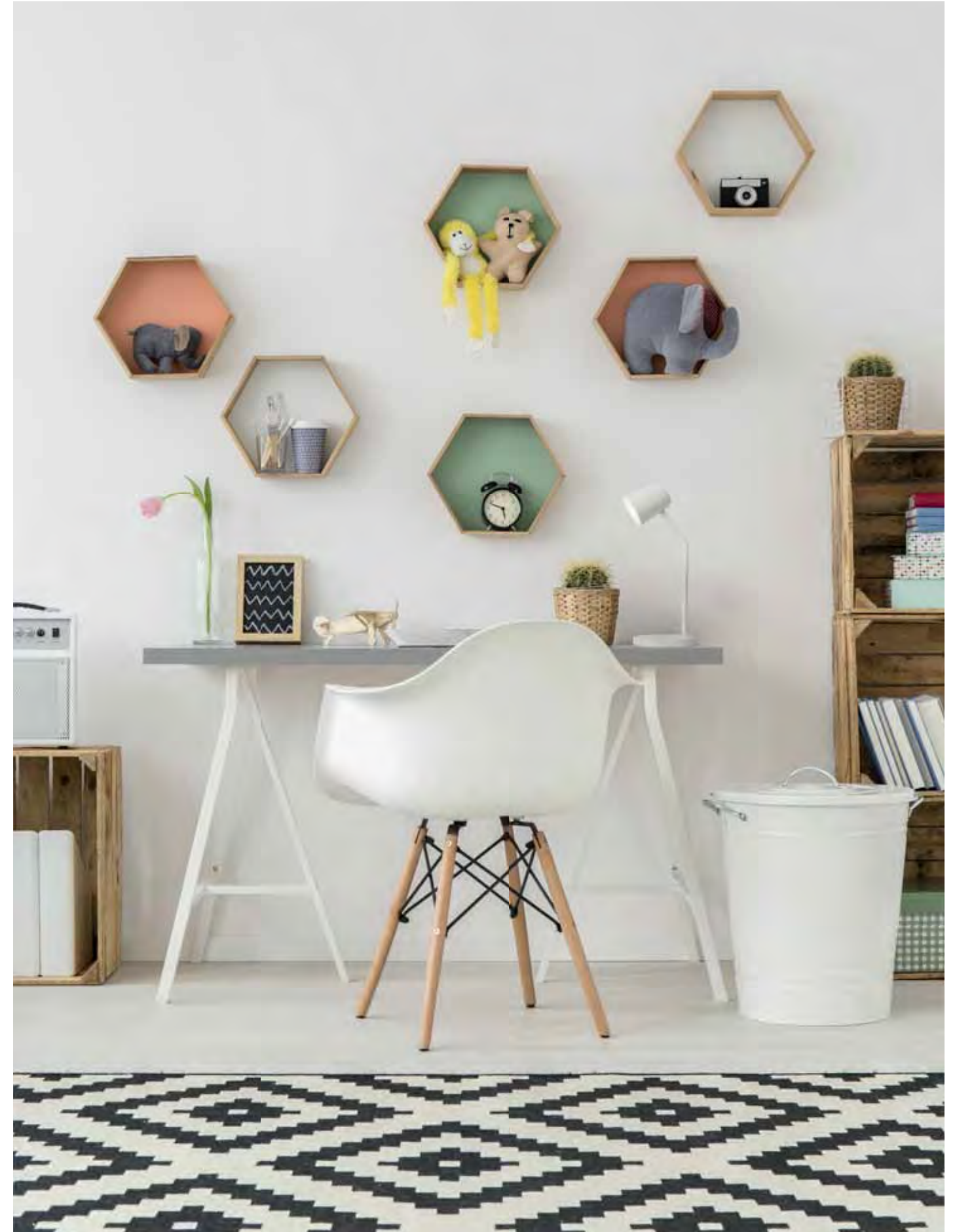
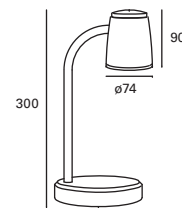



# Stol

- MAT Acero  
Steel  
Acier
- DIF Policarbonato  
Polycarbonate  
Polycarbonate
- Gris  
Grey  
Gris



360°



\*  
Puerto USB de 1 amperio de carga máxima.  
1 amp maximum load USB Port.  
Port USB de 1 ampère de charge maximale.

DE-0269-GRI ●

<b>W</b> TOTAL 5W	<b>LED</b> 4W 400 lm 3000°k	Included 100-240V 50-60Hz	Class II	6	360°	USB	✓
-------------------------	--------------------------------------	---------------------------------	----------	---	------	-----	---

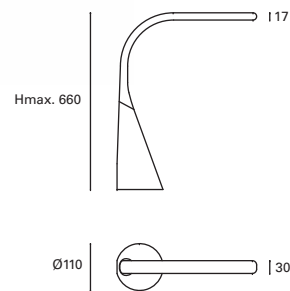

## Ding

Aluminio  
Aluminium  
AluminiumPolicarbonato  
Polycarbonate  
PolycarbonateBlanco  
White  
BlancNegro  
Black  
Noir

360°



\*  
Puerto USB de 1 amperio  
de carga máxima.  
1 amp maximum load  
USB Port.  
Port USB de 1 ampère de  
charge maximale.

DE-0271-BLA ○  
DE-0271-NEG ●

**W**  
TOTAL  
6,6W

**LED**  
4,8W  
520 lm  
3000°K

Included  
100-240V  
50-60Hz

Class II

6

360°

USB

✓

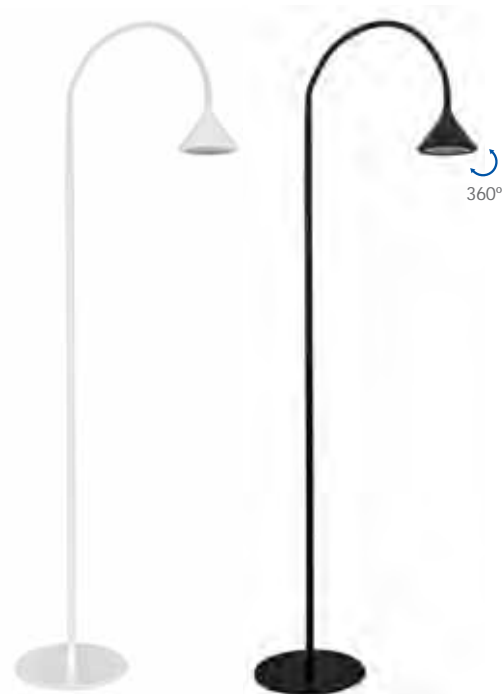
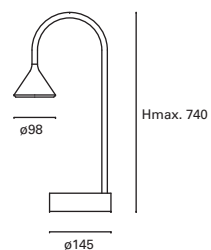

360°

DE-0272-BLA ○  
DE-0272-NEG ●

**W**  
TOTAL  
6,6W

**LED**  
4,8W  
520 lm  
3000°K

Included  
100-240V  
50-60Hz

Class II

4

360°

✓

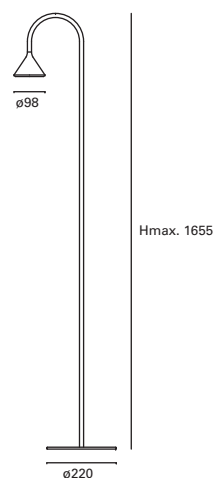



# Keeper NEW

MAT Acero Steel Acier

Blanco White Blanc

Negro Black Noir



DE-0479-BLA ○  
DE-0479-NEG ●

GU10  
 Max. 7W  
 L 64 mm - Ø 50 mm  
 V/Hz 100-240V 50-60Hz  
 Class I  
 24  
 355°  
 90°

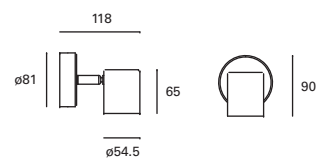

DE-0480-BLA ○  
DE-0480-NEG ●

2xGU10  
 2xMax. 7W  
 L 64 mm - Ø 50 mm  
 V/Hz 100-240V 50-60Hz  
 Class I  
 12  
 355°  
 90°

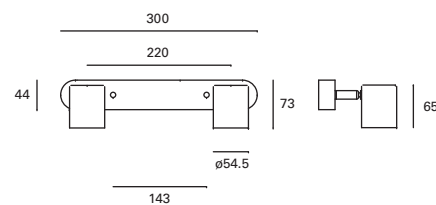

DE-0481-BLA ○  
DE-0481-NEG ●

3xGU10  
 3xMax. 7W  
 L 64 mm - Ø 50 mm  
 V/Hz 100-240V 50-60Hz  
 Class I  
 12  
 355°  
 90°

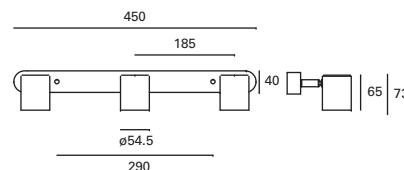

# Adri

MAT Acero + Polycarbonato  
Steel + Polycarbonate  
Acier + Polycarbonate

DIF Polycarbonato  
Polycarbonate  
Polycarbonate

Blanco  
White  
Blanc

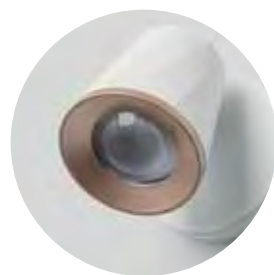

DE-0436-BLA ○

**W TOTAL** 5,1W  
**LED** 4,7W  
810 lm  
3000°k

Included 100-240V 50-60Hz

Class I 24 355° 90° ✓

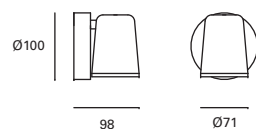

DE-0437-BLA ○

**W TOTAL** 10,2W  
**LED** 9,4W  
1620 lm  
3000°k

Included 100-240V 50-60Hz

Class I 12 355° 90° ✓

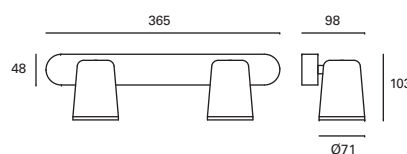

DE-0438-BLA ○

**W TOTAL** 15,3W  
**LED** 14,1W  
2430 lm  
3000°k

Included 100-240V 50-60Hz

Class I 12 355° 90° ✓

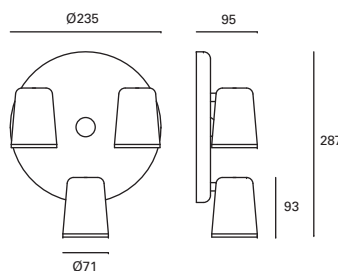



# Vitro

- MAT Acero Steel Acier
- Cromo Chrome Chrome

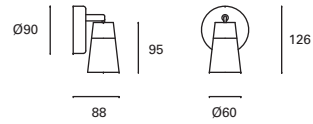

DE-0194-CRO

**W TOTAL** 6W  
**LED** 5W  
 700 lm  
 3000°k  
 Included 100-240V 50-60Hz  
 Class I  
 24  
 28°  
 350°  
 90°



\*  
 Cabezal en acabado níquel satinado.  
 Lente con confort visual.  
 Spot in satin nickel finish.  
 Visual comfort lens.  
 Projecteur en finition nickel satiné.  
 Objectif confort visuel.

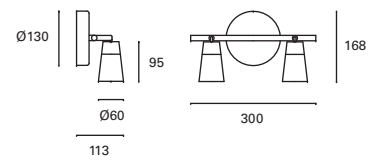

DE-0195-CRO

**W TOTAL** 12W  
**LED** 10W  
 1400 lm  
 3000°k  
 Included 100-240V 50-60Hz  
 Class I  
 12  
 28°  
 350°  
 90°

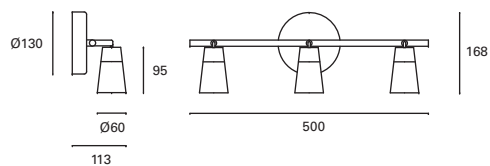

DE-0196-CRO

**W TOTAL** 18W  
**LED** 15W  
 2100 lm  
 3000°k  
 Included 100-240V 50-60Hz  
 Class I  
 12  
 28°  
 350°  
 90°





# Safran

MAT Acero Steel Acier

Marrón Brown Brun



DE-0225-MAR ●

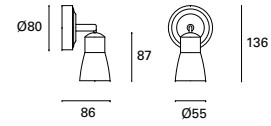

GU10 LED  
 Max. 7W  
 L 54 mm -  
 Ø 50 mm  
 V/Hz 100-240V  
 50-60Hz  
 Class I  
 24  
 350°  
 90°  
 ✓



DE-0226-MAR ●

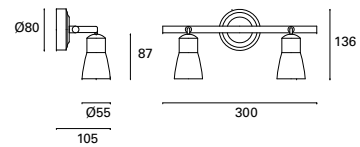

2xGU10 LED  
 2xMax. 7W  
 L 54 mm -  
 Ø 50 mm  
 V/Hz 100-240V  
 50-60Hz  
 Class I  
 12  
 350°  
 90°  
 ✓



DE-0227-MAR ●

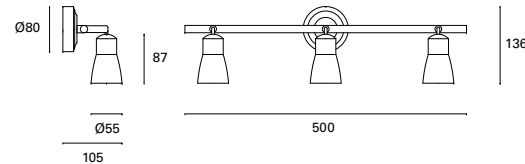

3xGU10 LED  
 3xMax. 7W  
 L 54 mm -  
 Ø 50 mm  
 V/Hz 100-240V  
 50-60Hz  
 Class I  
 12  
 350°  
 90°  
 ✓

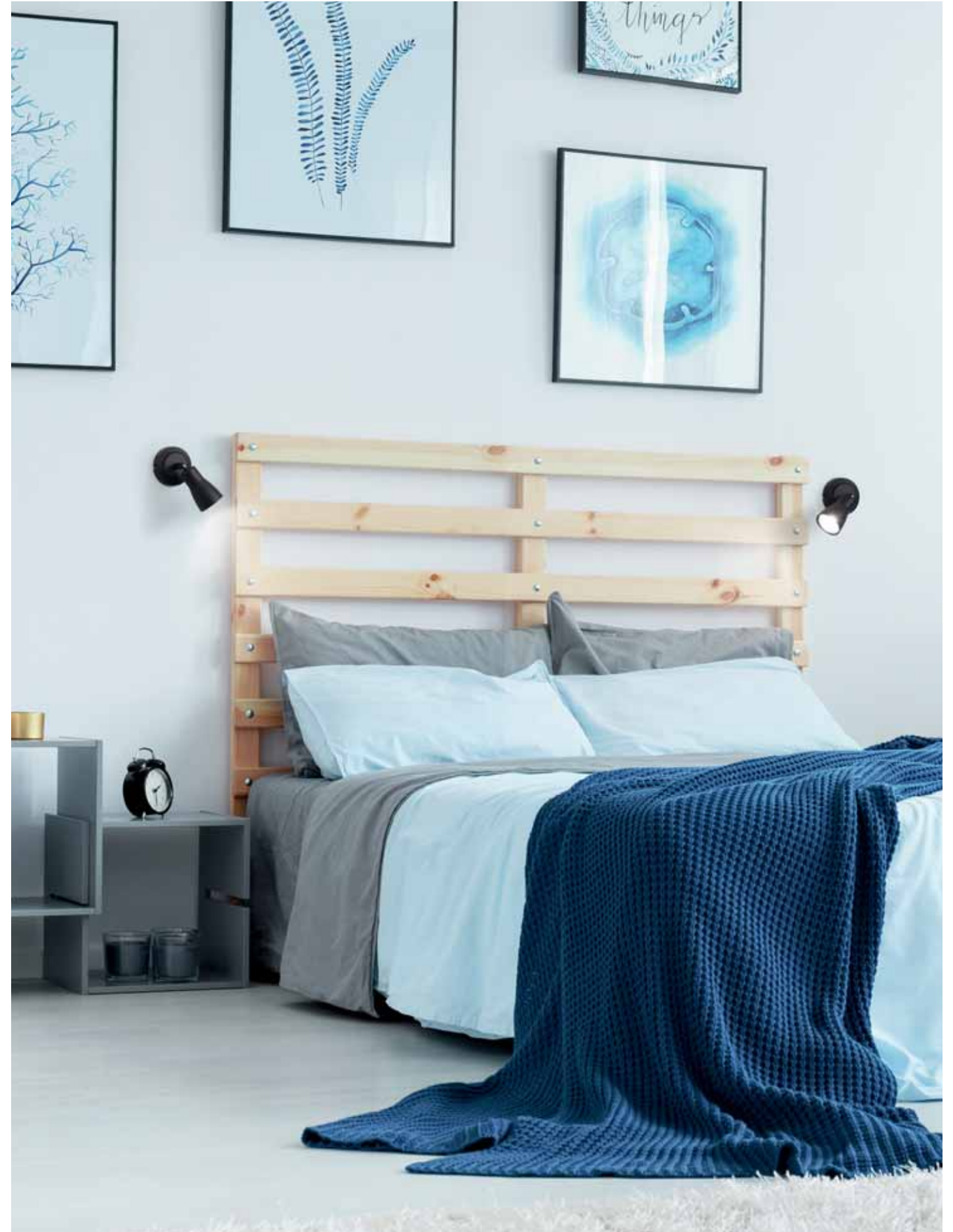



# Lungo

- MAT Acero  
Steel  
Acier
- DIF Policarbonato  
Polycarbonate  
Polycarbonate
- Cromo  
Chrome  
Chrome



**DE-0428-CRO**

<b>W</b> TOTAL 9,3W	<b>LED</b> 7,7W 910 lm 3000°K	Included 100-240V 50-60Hz	Class II	18	IP44	✓
---------------------------	--	---------------------------------	----------	----	------	---

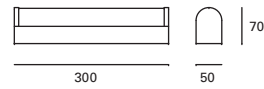

**DE-0429-CRO**

<b>W</b> TOTAL 13,3W	<b>LED</b> 11,5W 1365 lm 3000°K	Included 100-240V 50-60Hz	Class II	12	IP44	✓
----------------------------	--	---------------------------------	----------	----	------	---

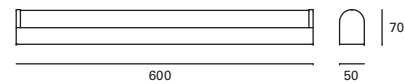

\*  
Apto para baños  
Suitable for bathrooms  
Convient pour salles de bains.



# Vapor

- MAT Acero  
Steel  
Acier
- DIF Cristal  
Glass  
Verre
- Cromo  
Chrome  
Chrome



DE-0426-CRO ●

<b>W</b> TOTAL 13,3W	<b>LED</b> 11,5W 1360 lm 3000°K	Included 100-240V 50-60Hz	Class II	6	IP44	✓
----------------------------	--	---------------------------------	----------	---	------	---

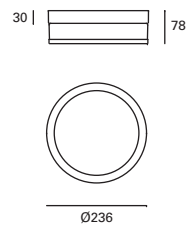

\*  
Apto para baños  
Suitable for bathrooms  
Convient pour salles de bains.



# Clock

MAT Acero inoxidable AISI 202  
AISI 202 Stainless steel  
Acier inoxydable AISI 202

DIF Policarbonato  
Polycarbonate  
Polycarbonate

Acero inoxidable  
Stainless steel  
Acier inoxydable



PX-0279-INO ●

<b>W</b> TOTAL	<b>LED</b>						
8W	7.2W 770 lm 4000°k	Included 110-240V 50-60Hz	Class II	6	IP44	IK10	✓

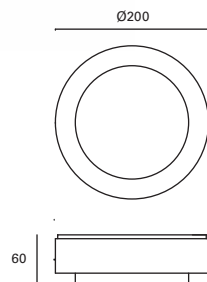

\*  
Ideal para instalar en baños gracias a su diseño y prestaciones.  
Perfect for bathrooms thanks to its performances and design.  
Idéals pour installer sur la salle de bains grâce à sa conception et prestations.



## Petit

- MAT Acero Steel Acier
- DIF Cristal Glass Verre
- Cromo Chrome Chrome



DE-0430-CRO ●

**W TOTAL** 7,1W  
**LED** 5,7W  
 650 lm  
 3000°k  
 Included 100-240V  
 50-60Hz  
 Class I  
 12  
 IP44

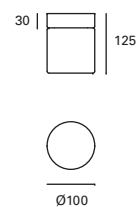

DE-0431-CRO ●

**W TOTAL** 7,1W  
**LED** 5,7W  
 650 lm  
 3000°k  
 Included 100-240V  
 50-60Hz  
 Class II  
 12  
 IP44

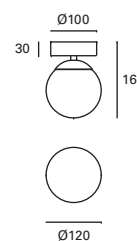

\*  
 Apto para baños  
 Suitable for bathrooms  
 Convient pour salles de bains.

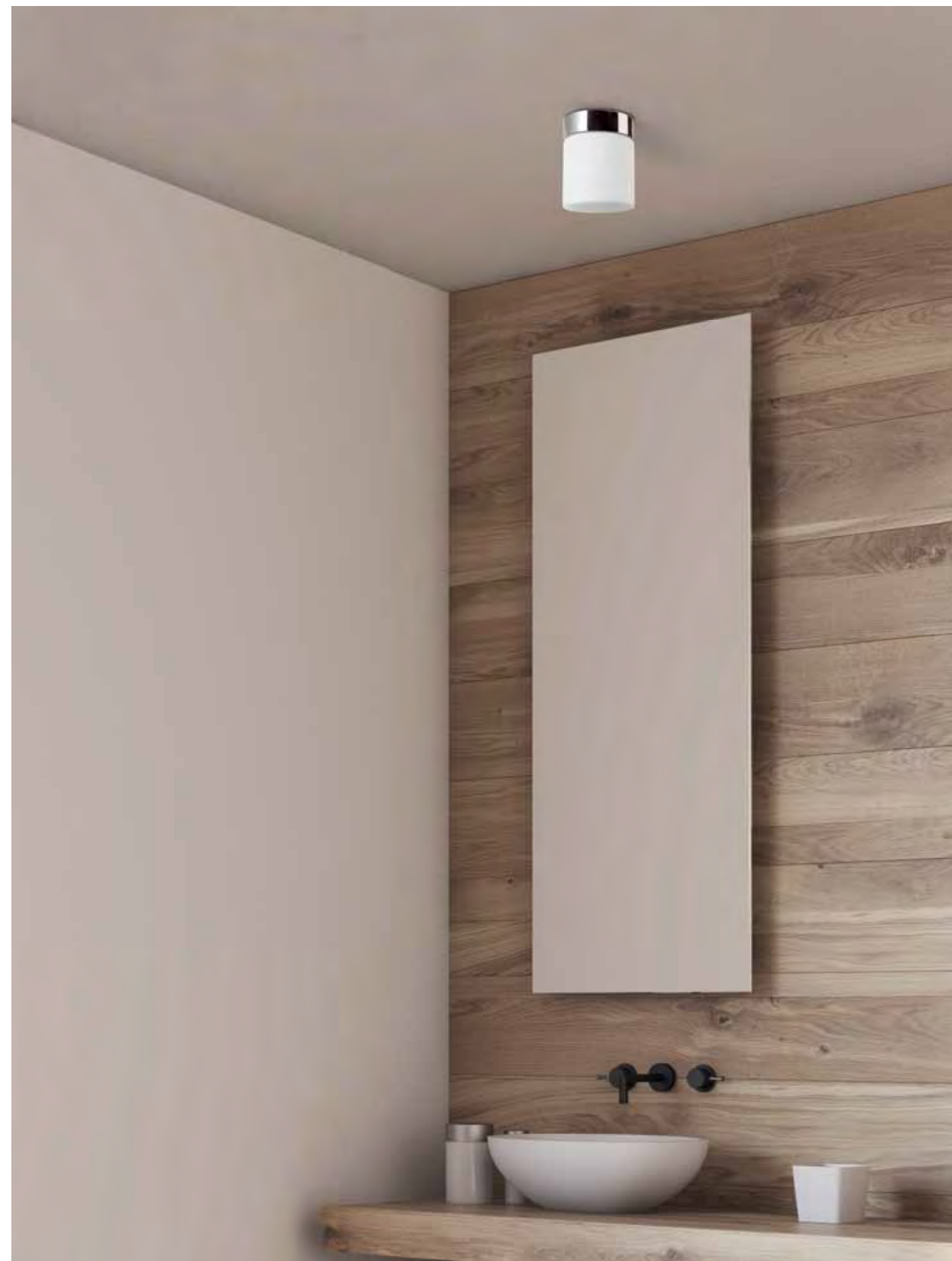





GARANTÍA WARRANTY GARANTIE

# DC MOTOR



Más del 50% de ahorro energético  
Over 50% energy saving  
Plus de 50% d'économie d'énergie



Mayor vida útil  
Longer working life  
Durée de vie utile allongée



Mayor control de la velocidad  
Higher speed control  
Meilleur contrôle de vitesse



Más silencioso  
More silent  
Plus silencieux



Mayor rapidez en los cambios  
Quicker changes  
Plus rapide dans les changements



Menor peso  
Lighter weight  
Moins lourd

## Cómo elegir su ventilador How to choose your fan Comment choisir votre ventilateur

### LUZ LIGHT LUMIÈRE



Con luz  
With light  
Avec lumière

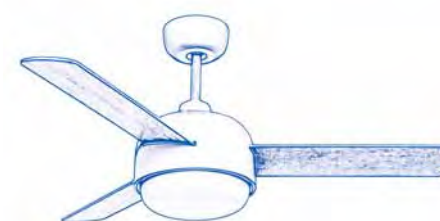

Sin luz  
Without light  
Sans lumière



### MEDIDA SIZE DIMENSION



< 15 m<sup>2</sup>



< 1000 mm



15 m<sup>2</sup> - 20 m<sup>2</sup>



> 1000 mm  
< 1320 mm



20 m<sup>2</sup> - 30 m<sup>2</sup>



> 1320 mm  
< 2000 mm



> 30 m<sup>2</sup>



> 2000 mm

### CONSEJOS ADVICES CONSEILS

#### Altura Height Hauteur

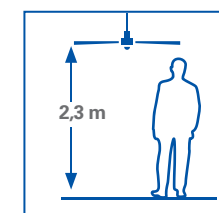

#### Instalación Installation Installation

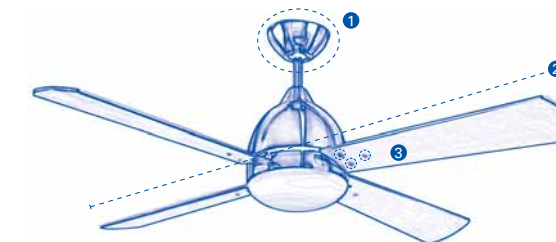

- 1 Fije correctamente el soporte y las palas.  
Fix the support and the blades correctly.  
Fixez correctement le support et les pales.
- 2 Utilice los contrapesos en caso de balanceo.  
If it is unstable, please use the counterweights.  
Utilisez les contrepoids en cas de balancement.
- 3 Finalmente tenga en cuenta que es necesario un periodo de 24h de asentamiento.  
It requires 24h settling period.  
Enfin, gardez à l'esprit qu'une période de tassement de 24 heures est nécessaire.

Instalación en techos con pendiente máxima de 15°  
To be installed on ceilings with 15° maximum inclination  
Installation sur plafonds à inclinaison maximale de 15°



# Inca NEW

- MAT Acero  
Steel  
Acier
- DIF Opal  
Opal  
Opale
- BLA  
MAT Contrachapado  
Plywood  
Contreplaqué
- Blanco mate  
White matt  
Blanc mat



**\***  
 Palas reversibles:  
 blanco y madera clara  
 Reversible blades:  
 white and light wood  
 Lames Réversibles:  
 blanc et bois clair



**VE-0001-BLA** ○

<b>W</b> TOTAL 18W	<b>LED</b> 18W 1530 lm 3000°k	<b>AIRFLOW</b> 4000 CFM								<b>V/Hz</b> 220-240V 50-60Hz		
--------------------------	--	-------------------------------	--	--	--	--	--	--	--	------------------------------------	--	--

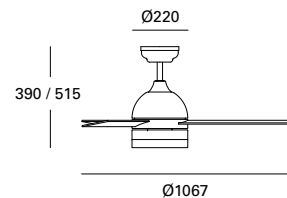

	1	2	3
<b>RPM</b>	167	210	220
<b>W</b>	25	41	49





# Helix NEW

- MAT Acero  
Steel  
Acier
- DIF Opal  
Opal  
Opale
- BLA  
MAT Acrílico  
Acrylic  
Acrylique
- Blanco mate  
White matt  
Blanc mat
- Imitación madera  
Imitation wood  
Imitation bois



VE-0002-BLA ○  
VE-0002-MAD ●

<b>W</b> TOTAL 6W	<b>LED</b> 6W 540 lm 3000°k	<b>AIRFLOW</b> 4500 CFM							<b>V/Hz</b> 220-240V 50-60Hz		
-------------------------	--------------------------------------	-------------------------------	--	--	--	--	--	--	------------------------------------	--	--

Included 220-240V 50-60Hz

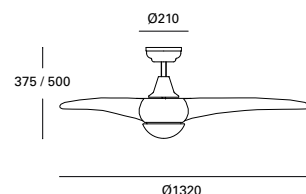

	1	2	3	4	5
<b>RPM</b>	99	132	156	175	204
<b>W</b>	4	8	14	21	36



**Core** NEW

**MAT** Acero  
Steel  
Acier

**DIF** Opal  
Opal  
Opale

**BLA  
MAT** ABS  
ABS  
ABS

**○** Blanco mate  
White matt  
Blanc mat



**VE-0003-BLA ○**

<b>W</b> TOTAL 11W	<b>LED</b> 9W 1100 lm 2700°k	<b>AIRFLOW</b> 4000 CFM								<b>V/Hz</b> 220-240V 50-60Hz		
										Included 220-240V 50-60Hz		

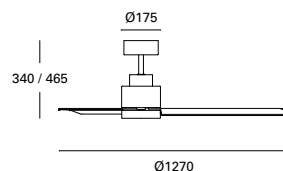

	1	2	3	4	5
<b>RPM</b>	110	132	169	200	220
<b>W</b>	4	6	12	19	25





Windy NEW

MAT Acero  
Steel  
Acier

BLA MAT Contrachapado  
Plywood  
Contreplaqué

Blanco  
White  
Blanc



\*  
Palas reversibles:  
blanco y madera clara  
Reversible blades:  
white and light wood  
Lames Réversibles:  
blanc et bois clair

VE-0004-BLA ○

AIRFLOW 3776 CFM 3 1 220-240V 50-60Hz Class I

	1	2	3
RPM	85	145	225
W	6	16	43

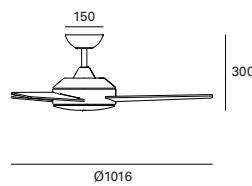

MAT Acero  
Steel  
Acier

DIF Cristal  
Glass  
Verre

BLA MAT Contrachapado  
Plywood  
Contreplaqué

Blanco  
White  
Blanc



\*  
Palas reversibles: blanco  
y madera clara  
Reversible blades: white  
and light wood  
Lames Réversibles: blanc  
et bois clair

VE-0005-BLA ○

2xE-27 Max.40W L 130 mm - Ø 85 mm AIRFLOW 3776 CFM 3 1 220-240V 50-60Hz Class I

	1	2	3
RPM	85	145	225
W	6	16	43

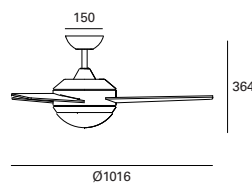

Borneo NEW

MAT

Acero  
Steel  
Acier

DIF

Opal  
Opal  
OpaleBLA  
MATContrachapado  
Plywood  
Contreplaqué

Blanco mate

Matt white  
Blanc mat

Níquel satinado

Satin nickel  
Nickel satiné

Marrón oscuro

Dark brown  
Marron foncé

Patiné

Antique brass  
Patiné

VE-0006-BLA ○

2xE-27  
Max.60W  
L 140 mm -  
Ø 45 mm

AIRFLOW 3776 CFM 3

3 1

V/Hz 230V 50Hz Class I ✓

	1	2	3
RPM	100	145	185
W	12	21	40



\*  
Palas reversibles:  
blanco y níquel satinado  
Reversible blades:  
white and satin nickel  
Lames Réversibles:  
blanc et nickel satiné

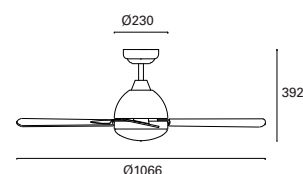

VE-0006-MAR ●

2xE-27  
Max.60W  
L 140 mm -  
Ø 45 mm

AIRFLOW 3776 CFM 3

3 1

V/Hz 230V 50Hz Class I ✓

	1	2	3
RPM	100	145	185
W	12	21	40



\*  
Palas reversibles: marrón  
oscura y madera clara  
Reversible blades: dark  
brown and light wood  
Lames Réversibles:  
marron foncé et bois clair

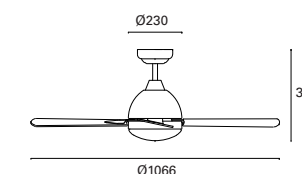

VE-0006-SAT ●

2xE-27  
Max.60W  
L 140 mm -  
Ø 45 mm

AIRFLOW 3776 CFM 3

3 1

V/Hz 230V 50Hz Class I ✓

	1	2	3
RPM	100	145	185
W	12	21	40



\*  
Palas reversibles:  
blanco y níquel satinado  
Reversible blades:  
white and satin nickel  
Lames Réversibles:  
blanc et nickel satiné

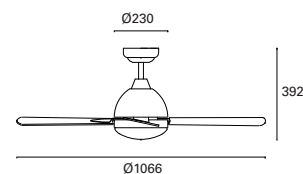

VE-0006-PAT ●

2xE-27  
Max.60W  
L 140 mm -  
Ø 45 mm

AIRFLOW 3776 CFM 3

3 1

V/Hz 230V 50Hz Class I ✓

	1	2	3
RPM	100	145	185
W	12	21	40



\*  
Palas reversibles:  
teca y haya  
Reversible blades:  
teak and beech  
Lames Réversibles:  
tek et hêtre

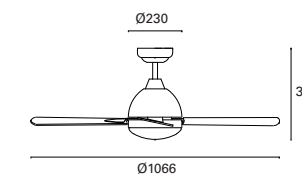





# Lace NEW

MAT Acero  
Steel  
Acier

BLA MAT Acero  
Steel  
Acier

Blanco mate  
White matt  
Blanc mat

Gris  
Grey  
Gris



DC MOTOR

VE-0007-BLA ○

AIRFLOW 3776 CFM **V/Hz** 100-240V 50-60Hz

	1	2	3	4	5
<b>RPM</b>	136	180	206	236	266
<b>W</b>	3,8	6,5	9,2	13,5	22,6

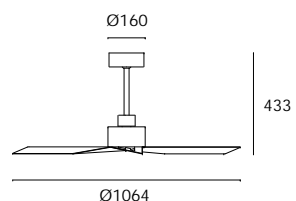

DC MOTOR

VE-0007-GRI ●

AIRFLOW 3776 CFM **V/Hz** 100-240V 50-60Hz

	1	2	3	4	5
<b>RPM</b>	136	180	206	236	266
<b>W</b>	3,8	6,5	9,2	13,5	22,6

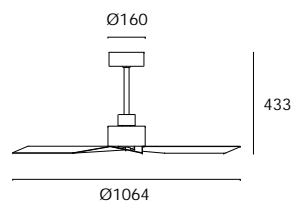



REFERENCE	PAGE	EAN13
DE-0180-BLA	194	8435381449193
DE-0180-NEG	194	8435381449209
DE-0182-NEG	196	8435381449469
DE-0194-CRO	232	8435381449421
DE-0195-CRO	232	8435381449438
DE-0196-CRO	232	8435381449445
DE-0198-BLA	202	8435381449513
DE-0199-BLA	202	8435381449520
DE-0225-MAR	234	8435381452643
DE-0226-MAR	234	8435381452650
DE-0227-MAR	234	8435381452667
DE-0229-BLA	208	8435381452735
DE-0231-BLA	210	8435381452902
DE-0232-BLA	210	8435381452919
DE-0233-BLA	193	8435381452759
DE-0234-RTJ	192	8435381456597
DE-0235-AZP	192	8435381456603
DE-0265-CEM	188	8435381456184
DE-0267-COR	196	8435381456580
DE-0267-ORO	196	8435381456573
DE-0268-BLA	204	8435381494520
DE-0268-NEG	204	8435381494537
DE-0269-GRI	224	8435381458744
DE-0271-BLA	226	8435381458669
DE-0271-NEG	226	8435381458676
DE-0272-BLA	226	8435381458683
DE-0272-NEG	226	8435381458690
DE-0311-CRI	198	8435381457129
DE-0313-ALU	200	8435381457150
DE-0314-ALU	200	8435381457167
DE-0381-SAT	212	8435381495343
DE-0382-SAT	212	8435381496449
DE-0383-SAT	212	8435381495350
DE-0424-BLA	210	8435381496463
DE-0426-CRO	238	8435381497811
DE-0428-CRO	236	8435381498108
DE-0429-CRO	236	8435381498115
DE-0430-CRO	242	8435381498986
DE-0431-CRO	242	8435381498993
DE-0436-BLA	230	8435381496395
DE-0437-BLA	230	8435381496401
DE-0438-BLA	230	8435381496418
DE-0442-SAT	204	8435381496456
DE-0474-BLA	114, 216	8435526865079
DE-0477-BLA	220	8435526866502
DE-0479-BLA	228	8435575318878
DE-0479-NEG	228	8435526866670
DE-0480-BLA	228	8435575318885
DE-0480-NEG	228	8435526866663
DE-0481-BLA	228	8435575318892
DE-0481-NEG	228	8435526866656
DE-0488-NEG	184	8435526867462
DE-0490-NEG	108, 218	8435526874019
DE-0492-BLA	220	8435575322653
DE-0500-BLA	222	8435575322790
DE-0500-NEG	222	8435575322806
DE-0508-NEG	184	8435575321564
DE-0509-BLA	206	8435381459536

REFERENCE	PAGE	EAN13
DE-0509-NEG	206	8435575322714
DE-0510-BLA	186	8435575322752
DE-0510-NEG	186	8435575322769
DE-0513-BLA	24, 202	8435575324237
DE-0518-CEM	190	8435575322615
DE-0519-CEM	190	8435575322622
DE-0520-CEM	190	8435575322639
PX-0005-ANT	138	8435381434878
PX-0005-GRI	138	8435111054772
PX-0024-OXI	178	8435111055250
PX-0025-OXI	178	8435111055274
PX-0026-OXI	178	8435111055267
PX-0027-OXI	179	8435111055281
PX-0028-OXI	160	8435111074800
PX-0029-MAR	174	8435111054925
PX-0030-MAR	174	8435111054932
PX-0031-MAR	175	8435111054901
PX-0033-ANT	167	8435111082492
PX-0034-ANT	167	8435111082393
PX-0047-GRI	82	8435381430085
PX-0056-GRI	129	8435381454234
PX-0056-NEG	129	8435381454227
PX-0063-OXI	159	8435111055465
PX-0086-ANT	171	8435381436636
PX-0087-ANT	171	8435381436643
PX-0095-GRI	148	8435381438371
PX-0096-ANT	102	8435381438388
PX-0097-ANT	102	8435381438395
PX-0098-ANT	173	8435381438463
PX-0098-BLA	173	8435381438432
PX-0098-INO	173	8435381454616
PX-0098-MAR	173	8435381438401
PX-0099-ANT	172	8435381438470
PX-0099-BLA	172	8435381438449
PX-0099-INO	172	8435381454623
PX-0099-MAR	172	8435381438418
PX-0100-ANT	172	8435381438487
PX-0100-INO	172	8435381454630
PX-0104-NEG	153	8435381438494
PX-0105-ANT	106	8435381448738
PX-0105-BLA	106	8435381438500
PX-0105-MAR	106	8435381448721
PX-0110-ANT	104	8435381438548
PX-0111-NEG	95	8435381438555
PX-0122-INO	84	8435381439828
PX-0123-INO	76	8435381440084
PX-0124-NEG	140	8435381440091
PX-0125-NEG	140	8435381440107
PX-0126-NEG	148	8435381440206
PX-0127-GRI	129	8435381448745
PX-0127-NEG	129	8435381448752
PX-0128-INO	76	8435381440817
PX-0129-NEG	150	8435381440824
PX-0130-NEG	148	8435381440954
PX-0139-NEG	164	8435381448929
PX-0142-GRI	100	8435381448769
PX-0142-NEG	100	8435381448776
PX-0144-NEG	95	8435381449544

REFERENCE	PAGE	EAN13
PX-0145-GRI	96	8435381449551
PX-0214-NEG	92	8435381452605
PX-0221-GRI	96	8435381452797
PX-0222-GRI	96	8435381452803
PX-0240-OXI	180	8435381454166
PX-0241-OXI	180	8435381454173
PX-0246-INO	158	8435381454241
PX-0248-GRI	100	8435381454654
PX-0248-NEG	100	8435381454265
PX-0251-INO	157	8435381456610
PX-0252-NEG	176	8435381454302
PX-0254-NEG	142	8435381457051
PX-0273-INO	158	8435381456535
PX-0276-BLA	144	8435381493806
PX-0276-GRI	144	8435381457099
PX-0277-INO	154	8435381457105
PX-0278-INO	154	8435381457112
PX-0279-INO	156, 240	8435381457068
PX-0280-NEG	163	8435381456641
PX-0281-NEG	150	8435381456160
PX-0282-NEG	162	8435381456658
PX-0284-GRI	84	8435381457310
PX-0285-GRI	84	8435381457327
PX-0352-BLA	145	8435381493783
PX-0352-GRI	145	8435381457082
PX-0352-NEG	145	8435381457075
PX-0353-GRI	143	8435381458843
PX-0353-NEG	143	8435381458836
PX-0354-INO	78	8435381458911
PX-0355-INO	76	8435381458928
PX-0361-NEG	95	8435381458706
PX-0365-NEG	86	8435381458652
PX-0374-NEG	92	8435381494452
PX-0375-ANT	116	8435381493714
PX-0375-BLA	116	8435381493691
PX-0376-ANT	116	8435381493745
PX-0376-BLA	116	8435381493721
PX-0378-GRI	136	8435381493912
PX-0378-NEG	136	8435381493929
PX-0379-GRI	136	8435381493936
PX-0379-NEG	136	8435381493943
PX-0380-GRI	137	8435381493950
PX-0380-NEG	137	8435381493967
PX-0395-GRI	132	8435381493882
PX-0395-NEG	132	8435381493851
PX-0396-GRI	132	8435381493868
PX-0396-NEG	132	8435381493875
PX-0397-GRI	124	8435381493899
PX-0397-NEG	124	8435381493905
PX-0432-ANT	126	8435381495251
PX-0432-BLA	126	8435381495244
PX-0433-ANT	130	8435381495237
PX-0433-BLA	130	8435381495220
PX-0439-NEG	146	8435381497248
PX-0464-GRI	98	8435526865673
PX-0465-INO	82	8435526865697
PX-0468-ANT	118	8435526867257
PX-0468-BLA	118	8435526867264

REFERENCE	PAGE	EAN13
PX-0470-ANT	90	84355268666243
PX-0478-BLA	108	8435526867271
PX-0486-NEG	169	8435526867356
PX-0487-NEG	169	8435526867349
PX-0493-BLA	120	8435575321618
PX-0493-GRI	120	8435575321625
PX-0493-NEG	120	8435575321632
PX-0507-BLA	152	8435575321588
PX-0507-NEG	152	8435575321595
PX-0514-ANT	26, 146	8435575324183
PX-0515-ANT	26, 165	8435575324190
PX-0516-NEG	26, 92	8435575324206
PX-0525-ANT	118	8435575320529
PX-0525-BLA	118	8435575320536
PX-0526-ANT	126	8435575320505
PX-0526-BLA	126	8435575320512
PX-0527-CEM	122	8435575320635
PX-0528-BLA	110, 214	8435575323834
PX-0529-NEG	112, 215	8435575348110
PX-1000-INO	78	8435381429973
PX-1100-NEG	80	8435381429980
PX-1200-NEG	80	8435381429997
PX-1400-BLA	88	8435381495268
PX-1400-GRI	88	8435381430023
PX-1400-NEG	88	8435381430016
PX-1801-BLA	101	8435381472856
PX-1801-GRI	101	8435381430047
PX-1900-BLA	134	8435381472832
PX-1900-GRI	134	8435111074626
PX-1900-NEG	134	8435381439798
PX-1901-BLA	134	8435381472849
PX-1901-GRI	134	8435111074619
PX-1901-NEG	134	8435381439804
TC-0131-BLA	41	8435381448837
TC-0134-BLA	50	8435381443757
TC-0135-BLA	50	8435381443740
TC-0146-BLA	54	8435381448936
TC-0146-GRI	54	8435381452841
TC-0147-BLA	54	8435381448943
TC-0147-GRI	54	8435526864669
TC-0148-BLA	54	8435381448950
TC-0148-GRI	54	8435381452858
TC-0149-BLA	54	8435381448967
TC-0150-BLA	54	8435381448974
TC-0150-GRI	54	8435381452865
TC-0151-BLA	54	8435381448981
TC-0152-BLA	55	8435381448998
TC-0152-GRI	55	8435526864706
TC-0153-BLA	55	8435381449001
TC-0153-GRI	55	8435526864713
TC-0154-BLA	55	8435381449018
TC-0154-GRI	55	8435381452872
TC-0155-BLA	55	8435381449025
TC-0156-BLA	55	8435381449032
TC-0156-GRI	55	8435381452889
TC-0157-BLA	55	8435381449049
TC-0158-BLA	57	8435381449056
TC-0159-BLA	57	8435381449063

REFERENCE	PAGE	EAN13
TC-0160-BLA	57	8435381449070
TC-0161-BLA	57	8435381449087
TC-0162-BLA	57	8435381449094
TC-0163-BLA	57	8435381449100
TC-0164-BLA	58	8435381449117
TC-0165-BLA	58	8435381449124
TC-0166-BLA	58	8435381449131
TC-0167-BLA	58	8435381449148
TC-0168-BLA	58	8435381449155
TC-0169-BLA	58	8435381449162
TC-0170-BLA	62	8435381449407
TC-0172-BLA	70	8435381448790
TC-0175-BLA	46	8435381449179
TC-0176-BLA	46	8435381449186
TC-0200-BLA	44	8435381449384
TC-0202-BLA	62	8435381449810
TC-0203-BLA	54	8435381452568
TC-0204-BLA	54	8435381452575
TC-0212-BLA	55	8435381452582
TC-0213-BLA	55	8435381452599
TC-0215-BLA	46	8435381450397
TC-0216-BLA	46	8435381450403
TC-0217-BLA	41	8435381450380
TC-0218-BLA	41	8435381450373
TC-0219-BLA	44, 45	8435381450410
TC-0220-BLA	45	8435381450427
TC-0303-BLA	45	8435381456559
TC-0304-BLA	45	8435381456672
TC-0305-BLA	45	8435381456566
TC-0306-BLA	38	8435381458874
TC-0316-BLA	35	8435381458348
TC-0349-BLA	66	8435381458881
TC-0350-BLA	66	8435381458898
TC-0357-BLA	30	8435381458850
TC-0357-NEG	30	8435381494544
TC-0358-BLA	30	8435381458867
TC-0358-NEG	30	8435381494551
TC-0360-BLA	34	8435381458768
TC-0366-BLA	45	8435381462161
TC-0411-BLA	57	843

Simbología  
 Symbols  
 Symboles

 <b>W TOTAL</b> xW Potencia total Total power Puissance totale	 <b>AIRFLOW</b> xxxx CFM Flujo de aire Air flow Flux d'air	 Luminarias conectables con WiFi o Bluetooth Wi-Fi or Bluetooth smart light fittings Luminaires connectables via WiFi ou Bluetooth	 Phase cut Regulador de intensidad Dimmer Régulateur d'intensité	 <b>V/Hz</b> xx-xxV xx-xxHz Voltaje / Frecuencia Voltage / Frequency Voltage / Fréquence	 Equipo electrónico incluido Electronic gear included Équipement électronique inclus	 Luminaria portátil Portable lamp Luminaire portable		
 Wireless charger Cargador inalámbrico Wireless charger Chargeur sansfil	 X Unidades de embalaje Items per box Unité d'emballage	 IPXX Grado de protección proporcionado por un envolvente contra la entrada de elementos sólidos y líquidos. Degree of protection that a casing provides against the penetration of solid objects or dust and liquids. Degré de protection contre la pénétration de corps solides, poussières et liquides	 Sea Side Suitable Adecuada para instalar en ambientes con atmósfera marina. Suitable for installation in environments with marine atmosphere. Adapté pour une installation en milieu marin.	 IKXX Grado de protección proporcionado por un envolvente contra los impactos mecánicos nocivos. Level of protection that a casing provides against damaging mechanical impacts. Degré de protection procuré par une enveloppe contre les impacts mécaniques nuisibles.	 xx° xx° Ángulo de las ópticas Lents angle Angle des lentilles	 x° x° Orientable Orientable Orientée		
 Class I	 Class II	 Class III	 Luminarias no adecuadas para el montaje directo en superficies normalmente inflamables Non suitable for direct installation on normally inflammable surfaces Luminaires non destinés à une installation directe sur des surfaces normalement inflammables	 Luminarias no adecuadas para cubrirse con material aislante térmico Luminaires should never be covered with any heat insulating material Ces luminaires ne doivent pas être recouverts de matériau thermo-isolant	 x,x M Distancia mínima entre el foco de la luminaria y el objeto iluminado Minimum distance to be left between the focus of the lighting fixture and the lightened object Distance minimale entre le foyer du luminaire et l'objet éclairé	 x,x m x metros de cable x meters of cable x mètres de câble	 Included Estaca incluida Spike included Piquet inclus	 Fotometría disponible Photometric data available Données photométriques disponible
 Mando a distancia Remote control Télécommande	 3 5 3 - 5 velocidades 3 - 5 speeds 3 - 5 vitesses	 Silencioso Silent Silencieux	 DC Motor	 Función inversa Reverse function Fonction inverse	 Palas reversibles Reversible blades Lames Réversibles	 Producto nuevo New product Nouveau produit	 Luminarias conectables Smart light fittings Luminaires connectables	
 <b>WARM&amp;COOL:</b> Permite ajustar la intensidad y la temperatura de color de la luz desde blanco cálido hasta blanco frío Allows you to adjust the light intensity and colour temperature, from warm white to cool white Permet de régler l'intensité et la température de couleur de la lumière, du blanc chaud au blanc froid	 <b>RGB:</b> Permite ajustar la intensidad y el color de la luz Allows you to adjust the light intensity and colour Permet de régler l'intensité et la couleur de la lumière	 Consultar disponibilidad Check availability Vérifiez la disponibilité						

Fuentes de luz  
 Light source  
 Sources lumineuses

- LED
- GU5.3
- GU10
- Par 38
- Par 30
- E27\*
- QR-111

\* También compatible con portalámparas E-26  
 Also compatible with E-26 lampholder  
 Aussi compatible avec douille E-26

Certificado de garantía  
 Warranty Certificate  
 Certificat de garantie

**LEDS C4, S.A.** garantiza al consumidor y usuario el correcto funcionamiento del producto y posibles reparaciones o suministro de recambios del modelo debidos a defectos de fabricación durante el periodo de **5 años** desde la fecha de entrega. En [www.forlight.com](http://www.forlight.com) se pueden consultar las condiciones de garantía, de las cuales destacamos las siguientes excepciones:

- En fuentes de luz LED, funcionamiento superior a **1500h por año o uso intensivo del producto.**
- Accidentes, o uso negligente, impropio o inadecuado.
- Daños producidos por sobrecargas eléctricas, inundaciones, plagas, terremotos, acciones de terceras partes o cualesquiera otras causas de fuerza mayor ajenas a las condiciones normales de funcionamiento del equipo y al control de LEDS C4, S.A.

This warranty certificate by **LEDS C4, S.A.** is for the consumer and user to guarantee the product works properly, and it covers the model's possible repairs and supply of spare parts due to manufacturing defects for a period of **five years** from the delivery date. The warranty terms and conditions can be consulted at the following link [www.forlight.com](http://www.forlight.com). Please take note of the following exceptions:

- LED light sources, which operate in excess of **1500h per year or are used continuously;**
- accidents or negligent, improper and inappropriate use;
- damage caused by electrical overloads, floods, infestations, earthquakes, actions of third parties or any other cause of force majeure beyond the normal operating conditions of the equipment and the control of LEDS C4, S.A.

**LEDS C4, S.A.** garantit au consommateur et utilisateur le fonctionnement correct du produit, ainsi que les éventuelles réparations ou la fourniture de pièces de rechange du modèle dues à des défauts de fabrication pendant une période de **5 ans** à compter de la date de livraison. Vous pouvez consulter les conditions de garantie sur [www.forlight.com](http://www.forlight.com), dont il convient de signaler les exceptions suivantes:

- En sources lumineuses LED, fonctionnement supérieur à **1500 h par an ou usage intensif du produit.**
- Accidents ou utilisation négligente, impropre ou inadéquate.
- Dommages occasionnés par des surcharges électriques, inondations, fléaux, tremblements de terre, actions de tiers ou toutes autres causes de force majeure indépendantes des conditions normales de fonctionnement du matériel et du contrôle de LEDS C4, S.A.

Información de tarifa  
 Price list information  
 Information tarifaire

Todos los precios indicados en el catálogo incluyen la tasa ECORAE.  
 All prices featured in the catalogue include the WEEE eco-fee.  
 Tous les prix indiqués dans le catalogue comprennent l'éco-participation DEEE.



**INFORMACIÓN EXTRA  
EXTRA INFORMATION  
INFORMATIONS SUPPLÉMENTAIRES**

Todos los derechos reservados. Ninguna parte de este libro puede ser reproducida en ningún formato de papel o electrónico, sin el consentimiento previo del editor o de los propietarios de los derechos. Ningún producto del catálogo incluye la bombilla, aunque ésta aparezca en las fotografías.

All rights reserved. No part of this publication may be reproduced or transmitted in any form or by any means, electronic storage and retrieval system, without permission in writing from the copyright owner(s). The products in this catalogue do not include bulbs, although bulbs may appear in the photos.

Tous droits réservés. Aucune partie de ce livre ne pourra être reproduite en format papier ou électronique sans l'autorisation préalable de l'éditeur ou du propriétaire des droits. Les produits de ce catalogue ne comprend pas l'ampoule, mais il semble sur les photos.

Debido a la constante evolución tecnológica del LED, los productos que incluyen esta fuente de luz pueden experimentar variaciones en sus características técnicas con el objetivo de poder ofrecer siempre las máximas prestaciones en nuestros productos.

Due to the constant evolution of LED technology, products containing this light source may vary in their technical characteristics so as to ensure that we can always offer maximum product performance.

En raison de l'évolution constante de la technologie LED, les produits dotés de cette source lumineuse peuvent connaître des variations dans leurs caractéristiques techniques, en vue de toujours en optimiser les prestations.

**HEADQUARTERS**

Afores s/n  
25750 Torà (Lleida) Spain  
+ 973 468 100  
leds-c4@leds-c4.com

**CUSTOMER SERVICE**

SPAIN  
+ 34 973 468 101  
spain@leds-c4.com

GERMANY  
Toll-free: 0800 188 0989  
deutschland@leds-c4.com

EUROPE  
+ 34 973 468 102  
europe@leds-c4.com

CANADA  
Toll-free: + 1-866-5636666  
usa@leds-c4.com

UNITED KINGDOM  
Free-phone: 0808 234 2641  
uk@leds-c4.com

ITALY  
Toll-free: 800 784 275  
italia@leds-c4.com

LATIN AMERICA  
+ 34 973 468 115  
latinamerica@leds-c4.com

UNITED STATES  
Toll-free: + 1-888-3710243  
usa@leds-c4.com

FRANCE  
+ 34 973 468 130  
france@leds-c4.com

PORTUGAL  
+ 34 973 468 130  
portugal@leds-c4.com

ASIA PACIFIC - AFRICA  
+ 34 973 468 116  
asiapacific@leds-c4.com  
africa@leds-c4.com

**MIDDLE EAST**

LEDS-C4 LIGHTING DMCC  
Fortune Executive Tower – JLT  
PO 336910 – DUBAI – UAE  
+ 971 4458 4272  
middleeast@leds-c4dubai.com

**POLAND**

LEDS-POLSKA SP Z O.O.  
ul.Nektarowa 11B 52-210.  
Wroclaw POLAND  
+ 48 71 733 64 01  
biuro@leds-polska.pl

**ASIA PACIFIC**

59 New Bridge Road  
059405 SINGAPORE  
+65 6532 2119  
asiapacific@leds-c4.com

**PRESS**

+ 34 973 468 117  
comunicacion@leds-c4.com

**SUPPLIERS**

+ 34 973 468 113  
compras@leds-c4.com





Afueras s/n 25750 Torà (Lleida) - Spain  
[www.forlight.com](http://www.forlight.com)  
Tf: + 34 973 468 100